

ASSEMBLY INSTRUCTIONS









383-000031

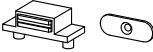

IMPORTANT

PLEASE READ BEFORE YOU CONTINUE FURTHER

1. MATERIAL USE LAMINATED PARTICLE BOARD, TO CLEAN USE SOFT, DRY CLOTH.
2. DO NOT USE DETERGENT OR CHEMICAL AVOID CONTACT WITH WATER AND DIRECT SUNLIGHT.
3. TO BE ASSEMBLED ON A SOFT, DRY, CLEAN SMOOTH SURFACE.
4. DO NOT USE ANY TOOLS OTHER THAN THOSE SHOWN.
5. USE OF POWER TOOLS TO ASSEMBLE THIS PRODUCT WILL INVALIDATE ANY CLAIM AND MAY DAMAGE THIS PRODUCT MAKING IT UNSAFE.
6. BEFORE STARTING ASSEMBLY PLEASE VERIFY IF ALL PARTS AND HARDWARE ARE INCLUDED.

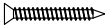

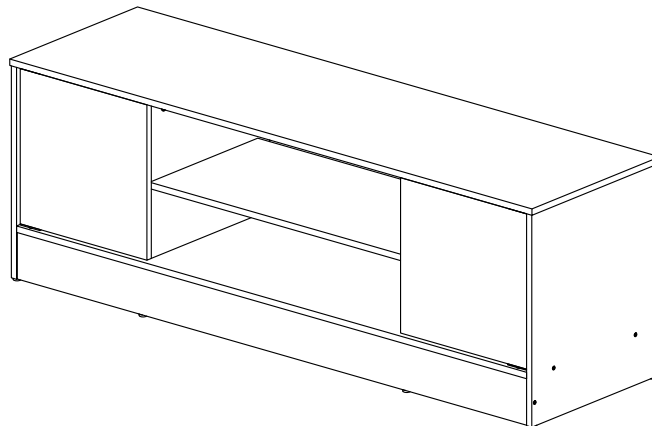
HARDWARE LIST			QTY (pcs)
DH3		Door Holder	4
DW4		Wood Dowel 6 x 25mm	28
LG1		Leg Pin	8
MF2		Nail	20 (+3)
MG1		Magnet Catch KD	2 Sets
MN1		Mini Fix 12mm	8 Sets
PF11		Small L Bracket	4
SC3		Screw M3.5 x 14mm	18
SC18		Screw M4 x 38mm	12

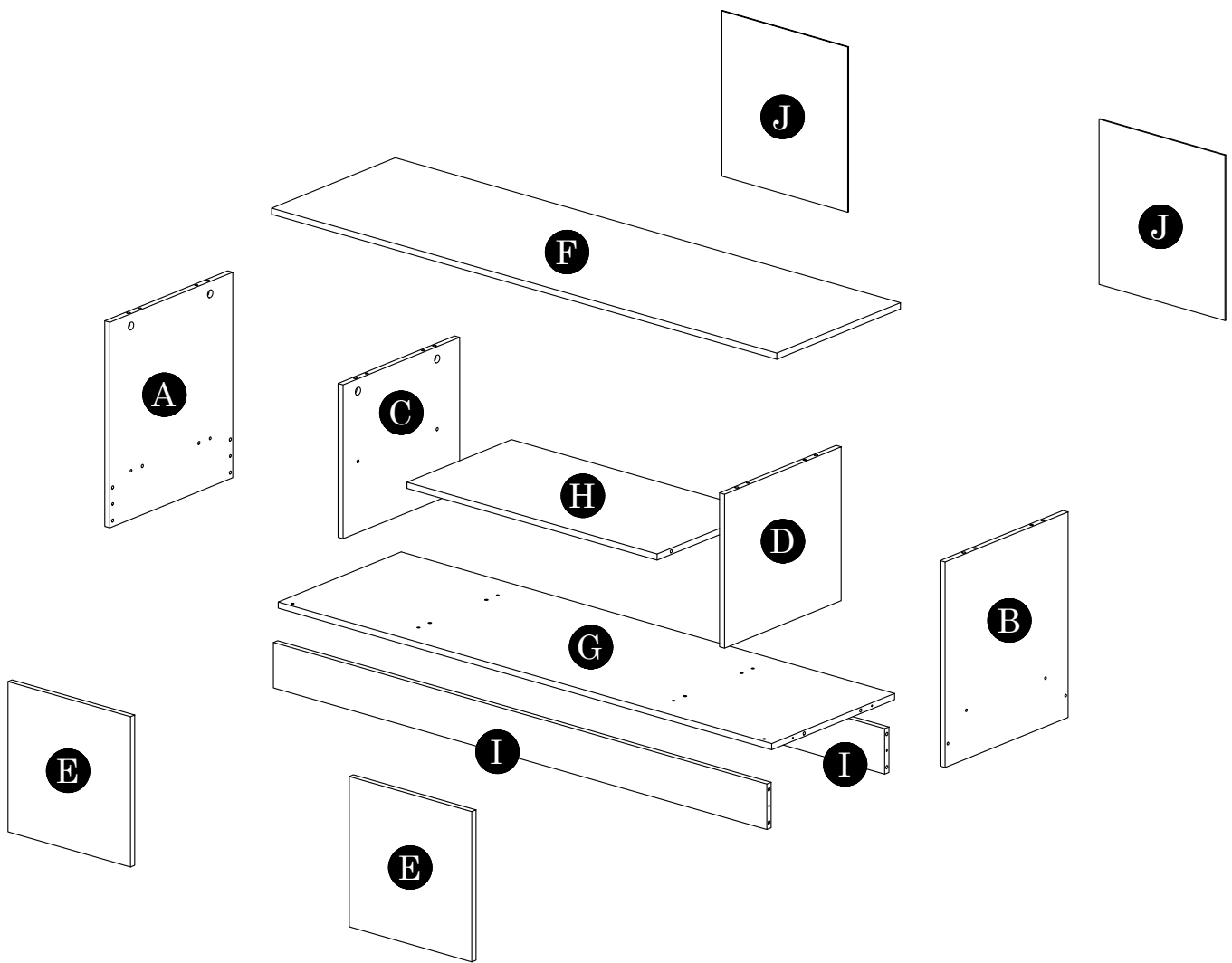

Parts List		QTY
A	Side Panel (L)	1 pc
B	Side Panel (R)	1 pc
C	Center Panel (L)	1 pc
D	Center Panel (R)	1 pc
E	Door Panel	2 pcs
F	Top Panel	1 pc
G	Bottom Panel	1 pc
H	Shelf Panel	1 pc
I	Bottom Crossbar	1 pc
J	Backboard	2 pcs



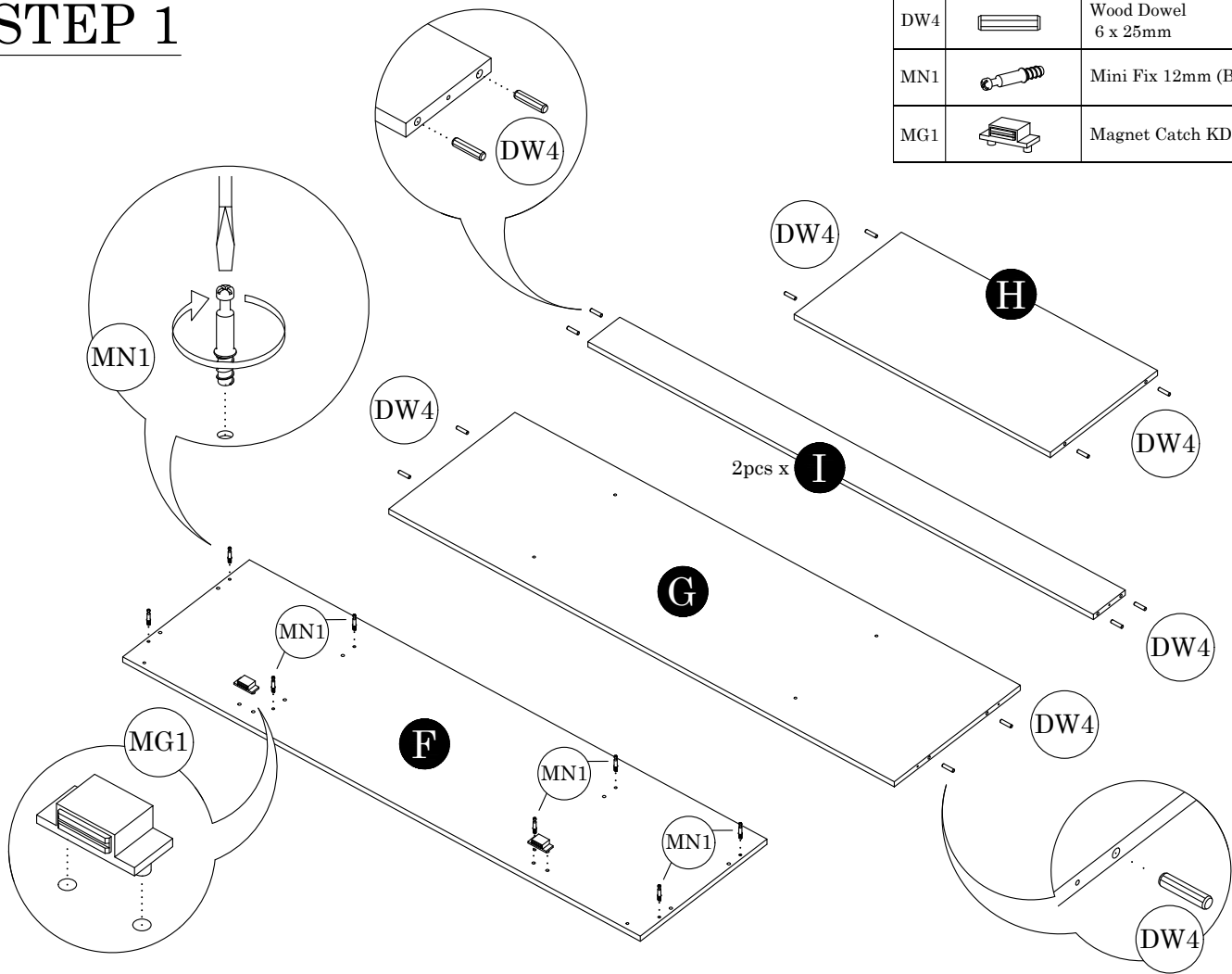

STEP 1

DW4		Wood Dowel 6 x 25mm	16
MN1		Mini Fix 12mm (Bolt)	8
MG1		Magnet Catch KD	2



STEP 2

DW4		Wood Dowel 6 x 25mm	12
MN1		Mini Fix 12mm (Cam)	8

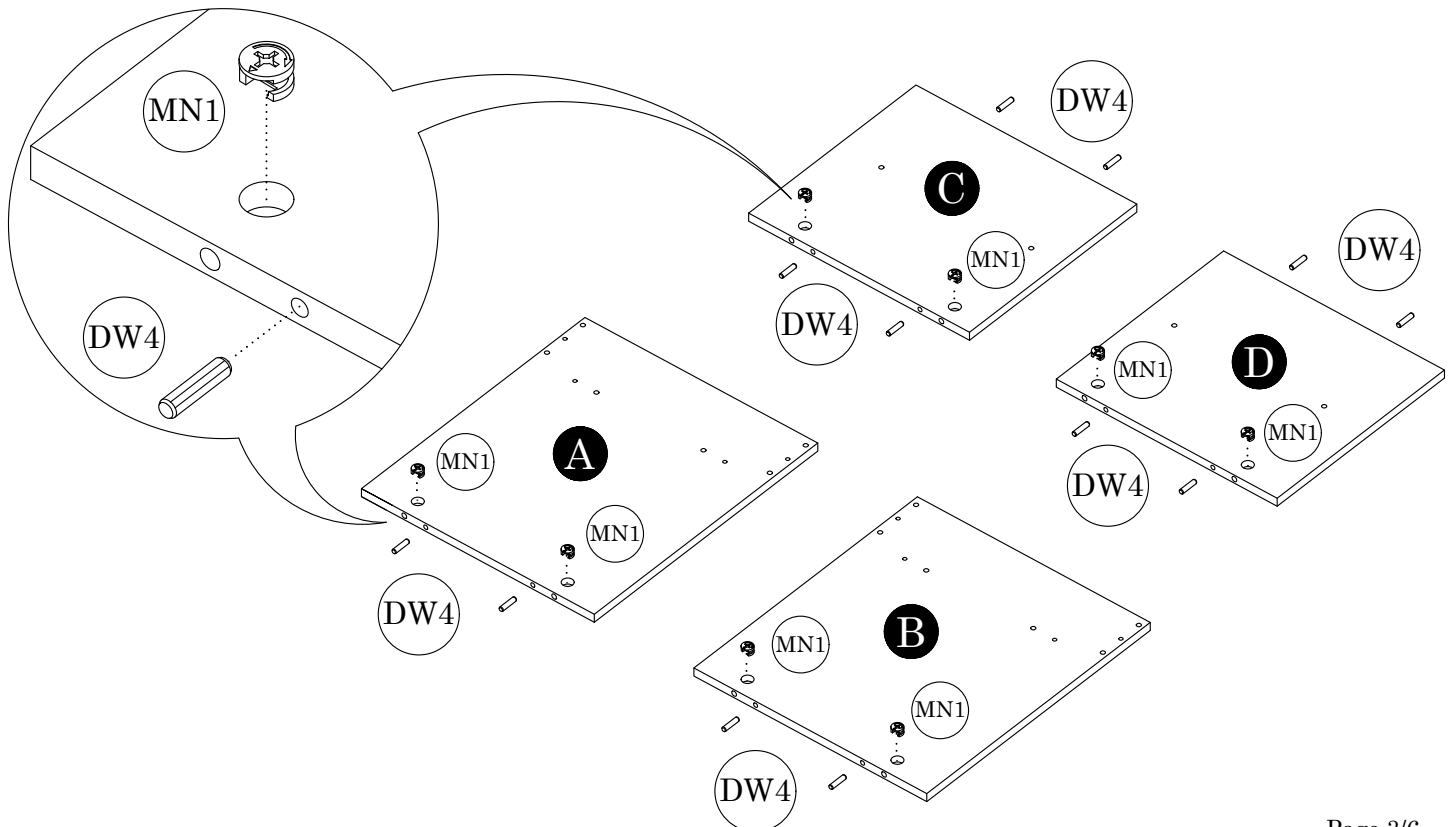

STEP 3

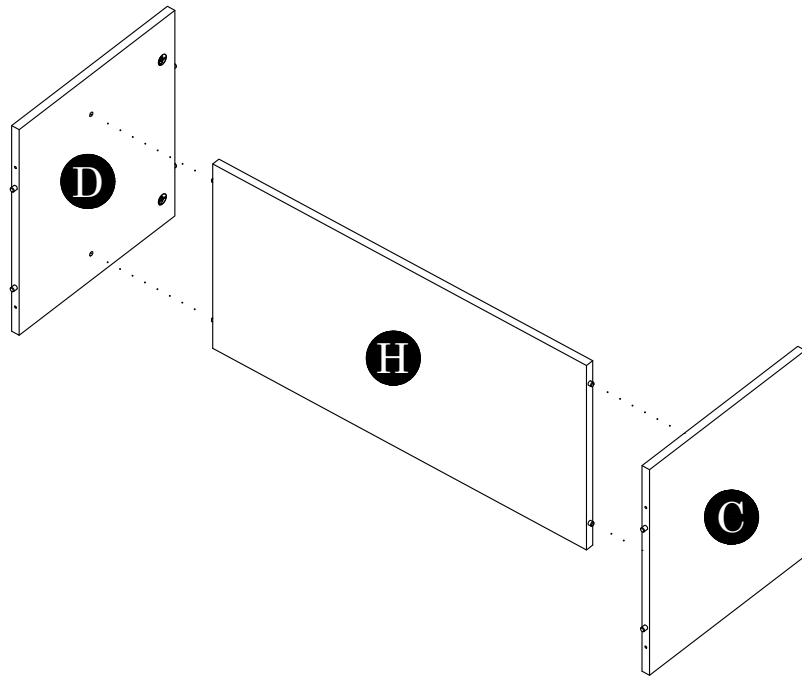



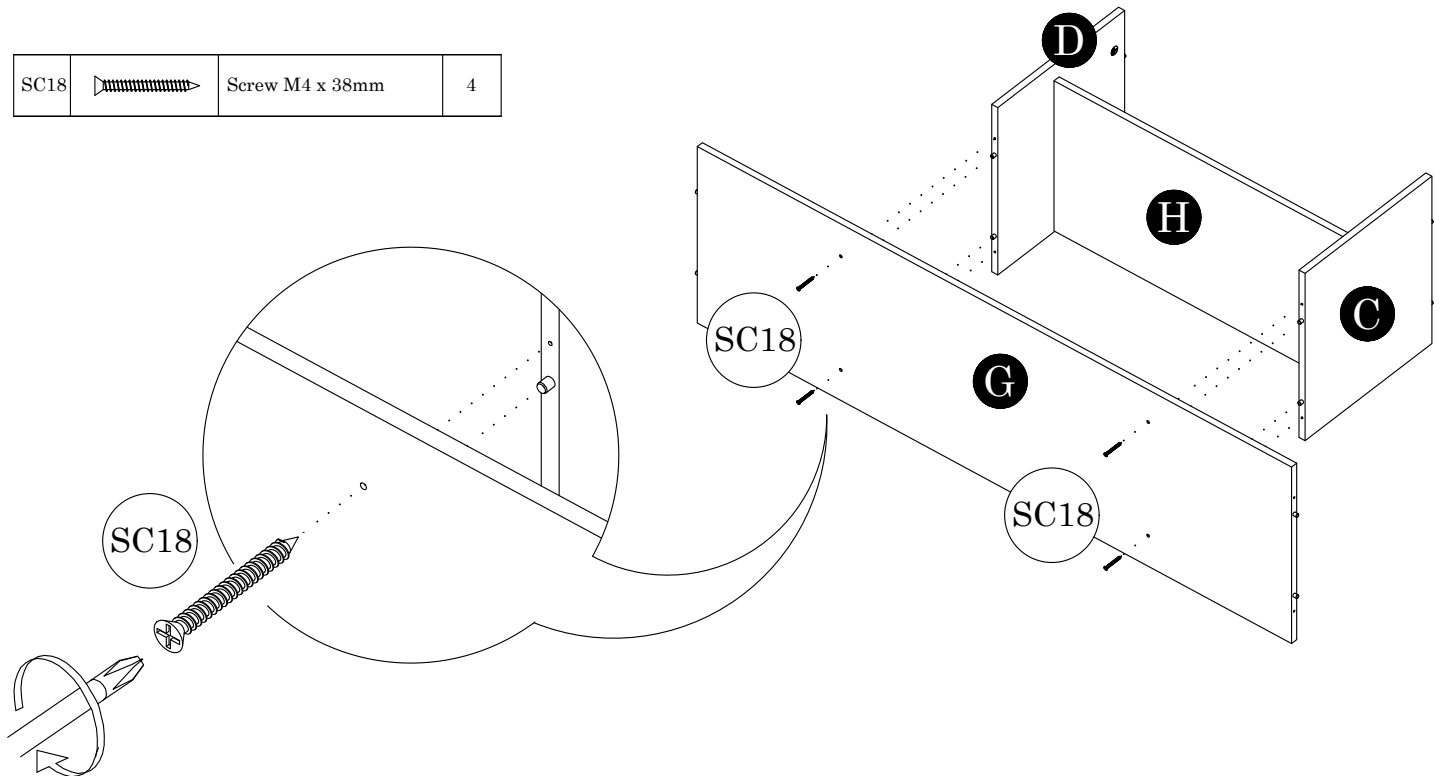

STEP 4

SC18		Screw M4 x 38mm	4
------	---	-----------------	---



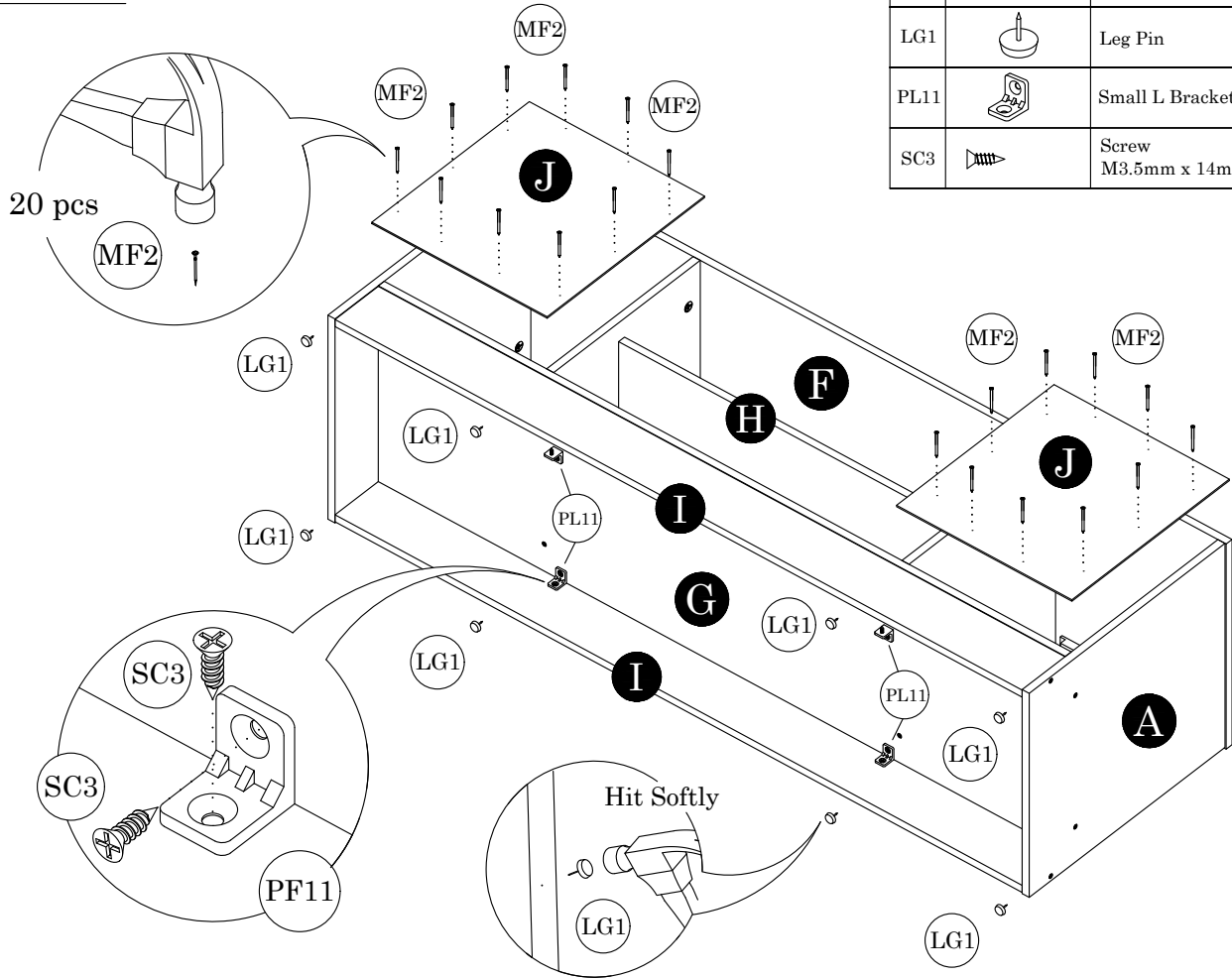

STEP 7

MF2		Nail	20 (+-3)
LG1		Leg Pin	8
PL11		Small L Bracket	4
SC3		Screw M3.5mm x 14mm	8



STEP 8

DH3		Door Holder	4
MG1		Magnet Catch KD	2
SC3		Screw M3.5mm x 14mm	10

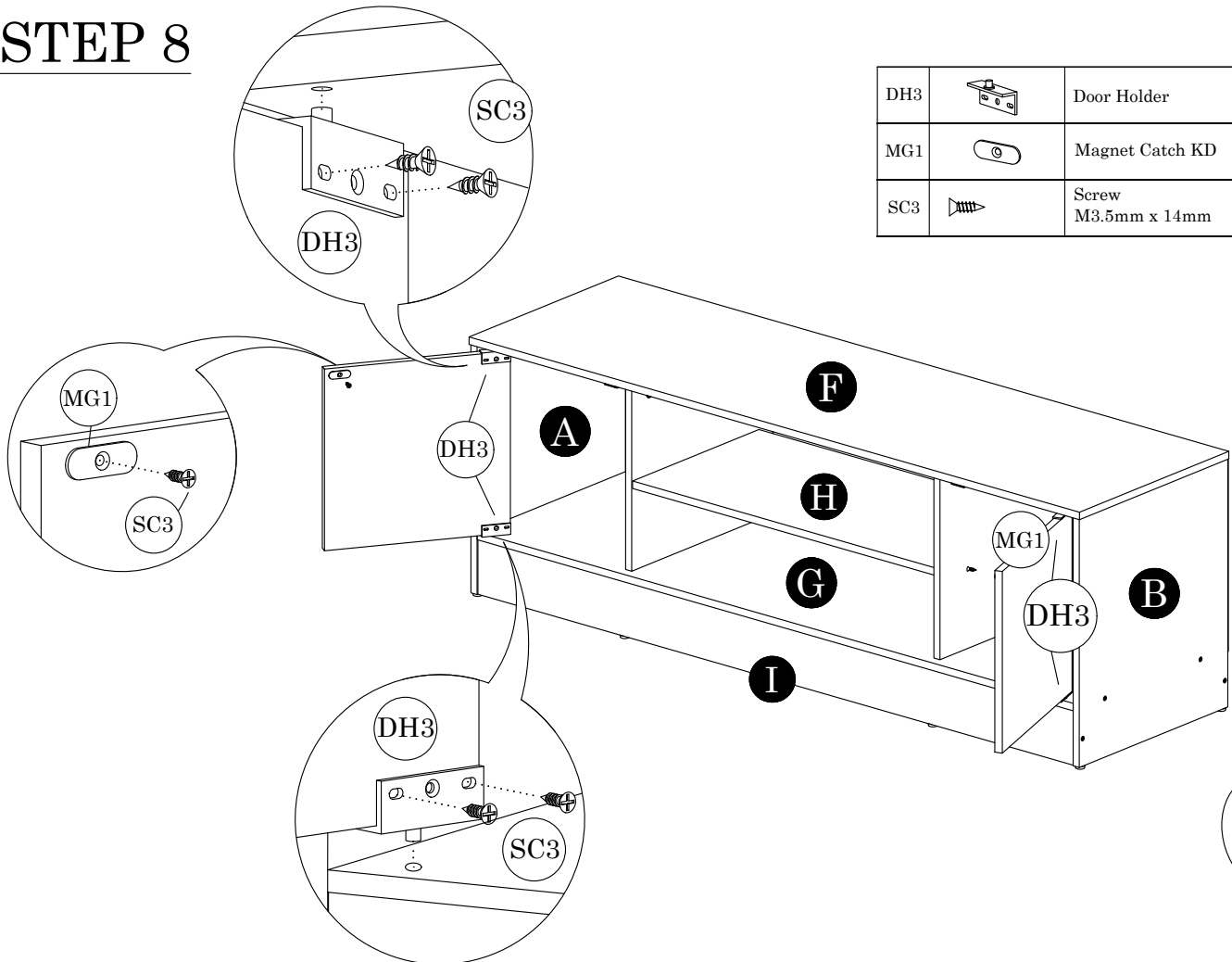

Stand up