

361-000071

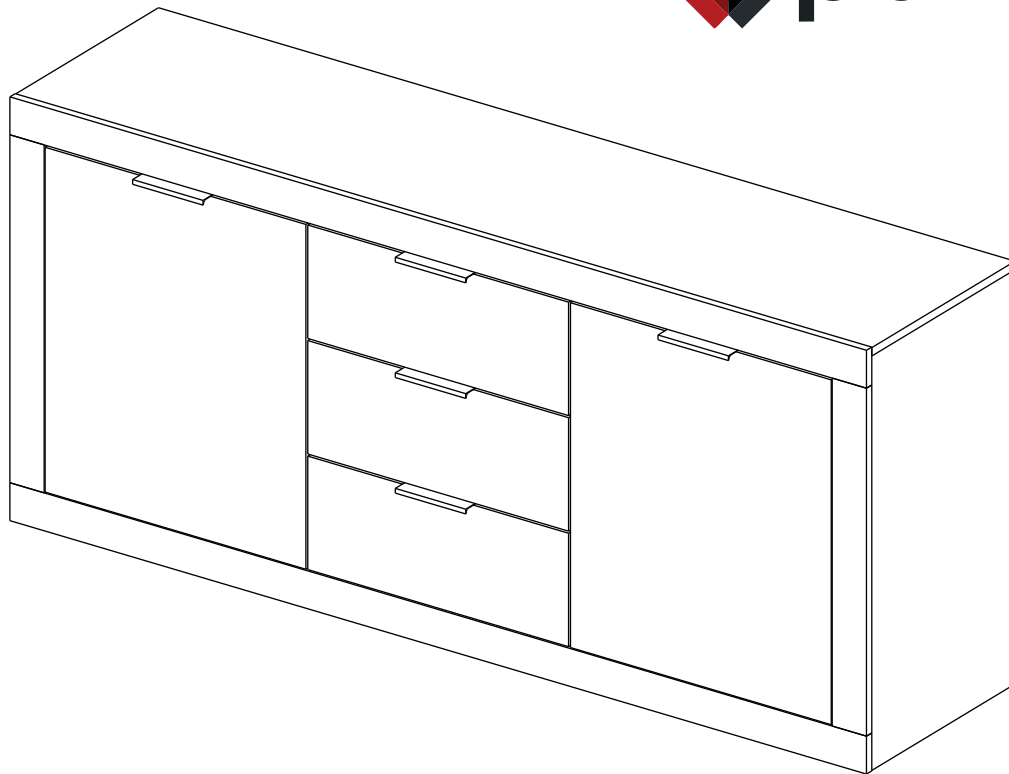

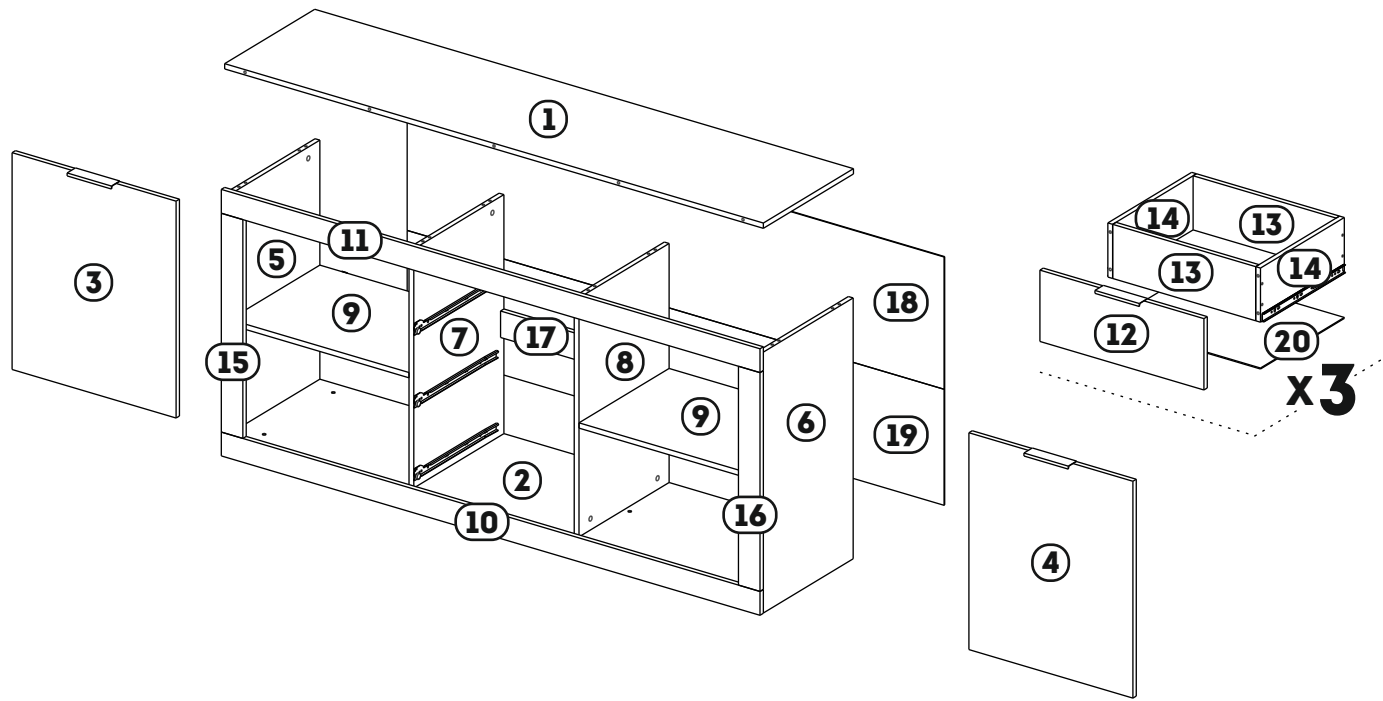

No	a*b	X	Pack
1	1800x430	1	1
2	1766x430	1	1
3	655x548	1	3
4	655x548	1	3
5	788x430	1	2
6	788x430	1	2
7	722x430	1	2
8	722x430	1	2
9	599x430	2	2
10	72x1800	1	1
11	72x1800	1	1
12	216x548	3	3
13	478x164	6	1
14	400x164	6	1
15	661x72	1	1
16	661x72	1	1
17	80x536	1	1
18	399x1794	1	1
19	351x1794	1	1
20	510x400	3	2

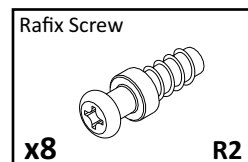
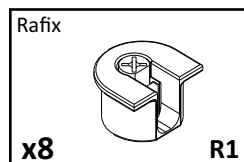
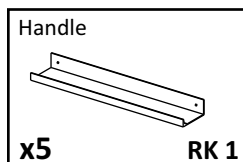
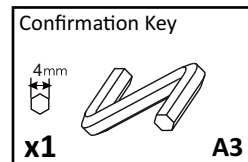
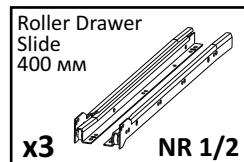
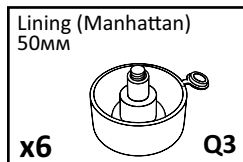
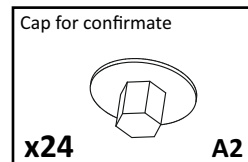
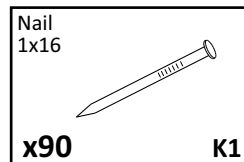
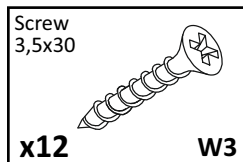
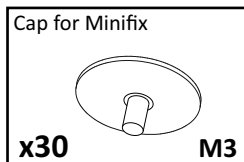
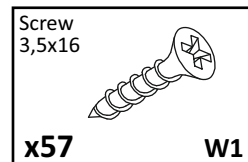
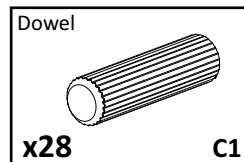
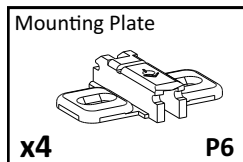
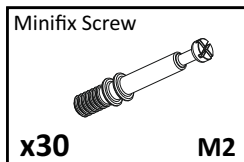
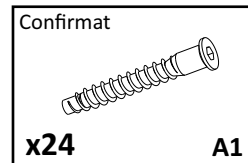
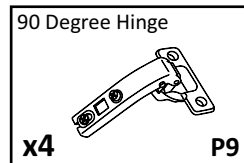
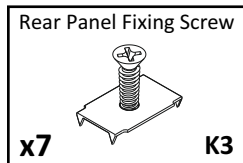
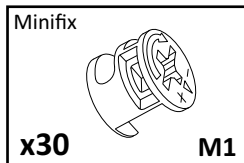

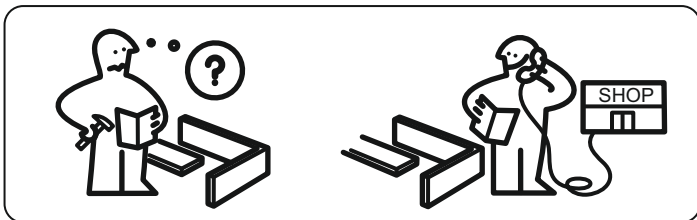
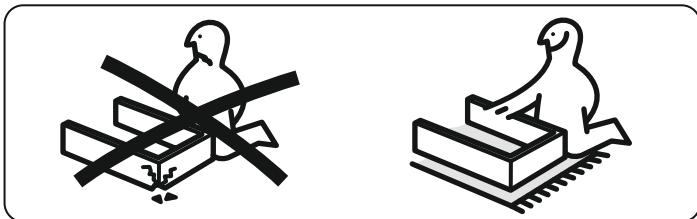
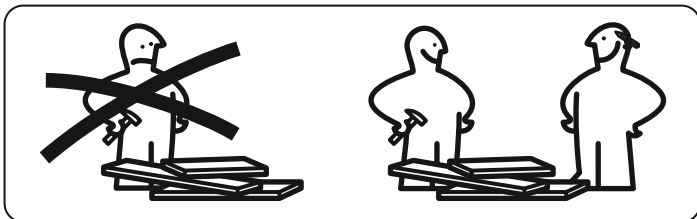

## GENERAL TECHNICAL INSTRUCTIONS FOR FURNITURE ASSEMBLY

- CHECK COMPATIBILITY OF PARTS AND ACCESSORIES BEFORE ASSEMBLY.
- FOR FURNITURE ASSEMBLY, WE RECOMMEND USING THE SERVICES OF QUALIFIED SPECIALISTS.
- DO ASSEMBLY ON A SURFACE COVERED WITH CLOTH OR CARDBOARD TO PREVENT SCRATCHES.

## CARE AND MAINTENANCE OF FURNITURE

- KEEP THE FURNITURE FROM PROLONGED CONTACT WITH WATER OR HOT STEAM.
- ENSURE SUFFICIENT DISTANCE FROM ELECTRICAL APPLIANCES AND HEATERS.
- IF THERE IS DIRTY ON THE FURNITURE, REMOVE IT WITH A DAMP CLOTH AND THEN WIPE IT DRY. DO NOT USE ABRASIVE MATERIALS.

**1**

Minifix

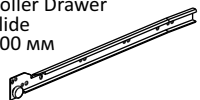
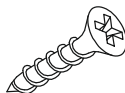
**x12****M1**Roller Drawer  
Slide  
400 mm**x3****NR 1**Screw  
3,5x16**x12****W1**

Rafix Screw

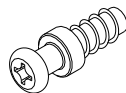
**x4****R2**

Minifix Screw

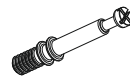
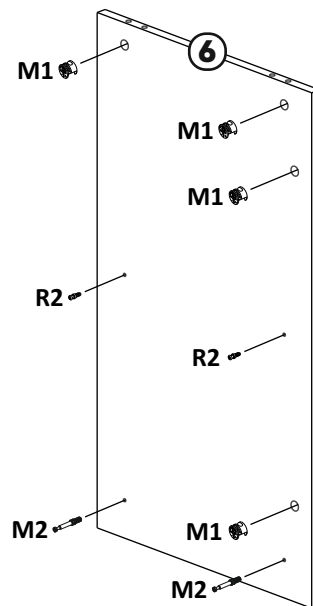
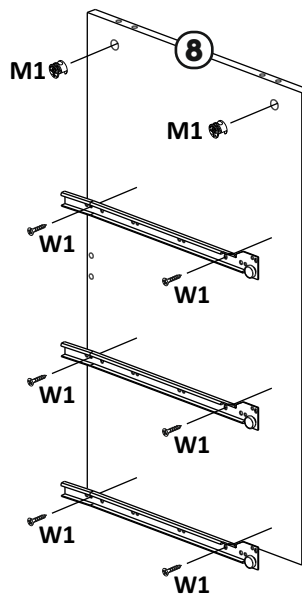
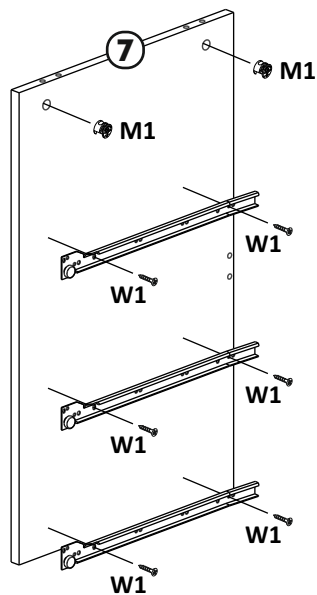
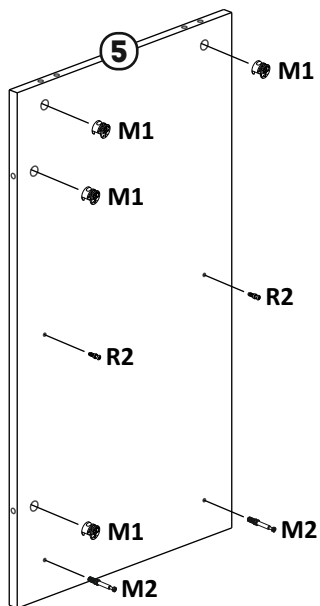
**x4****M2**

# 2

Minifix

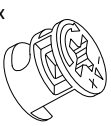

x14

M1

Dowel

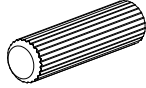

x8

C1

Minifix Screw

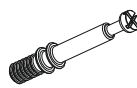

x8

M2

Lining (Manhattan)  
50mm

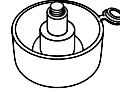

x6

Q3

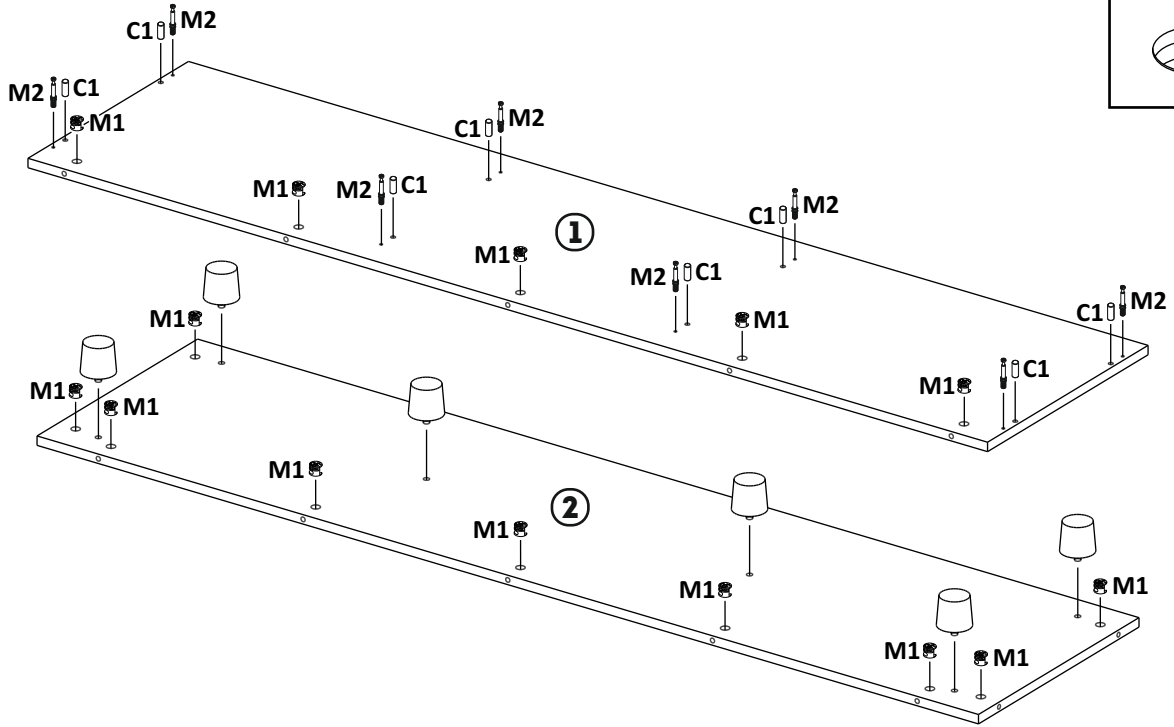
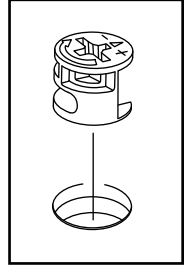

3

Dowel

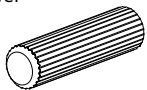

x4

C1

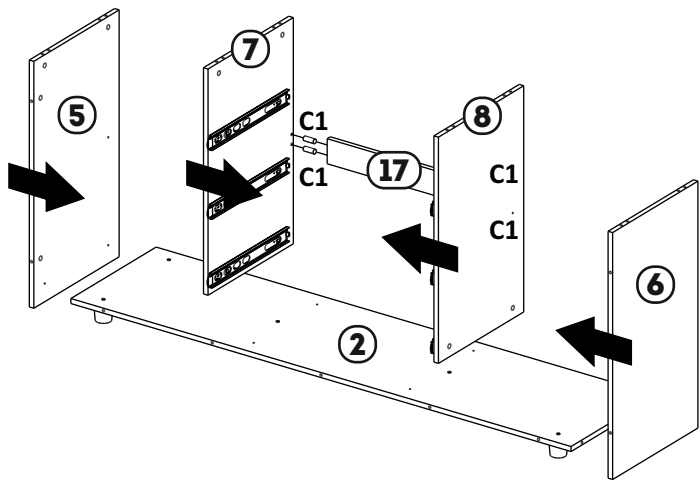
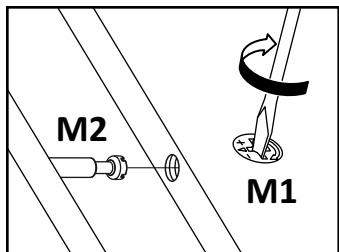

4

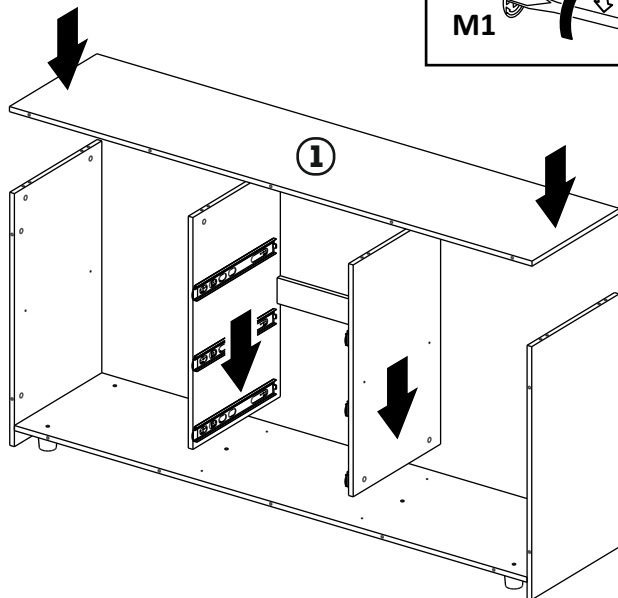
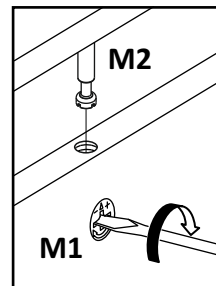

**5**

Rear Panel Fixing Screw

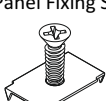

x7

K3

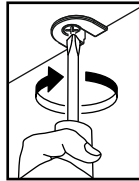
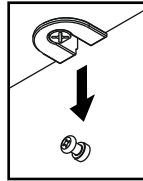
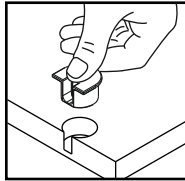
**6**

Minifix Screw

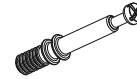

x14

M2

Mounting Plate

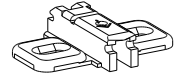

x4

P6

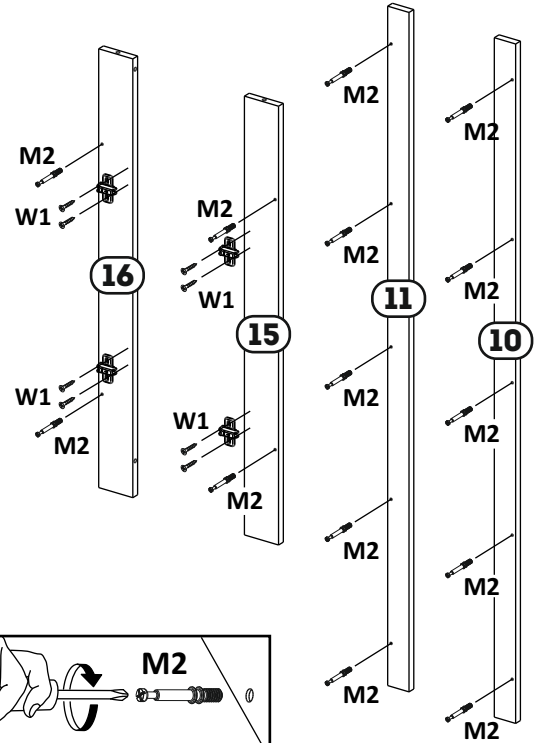
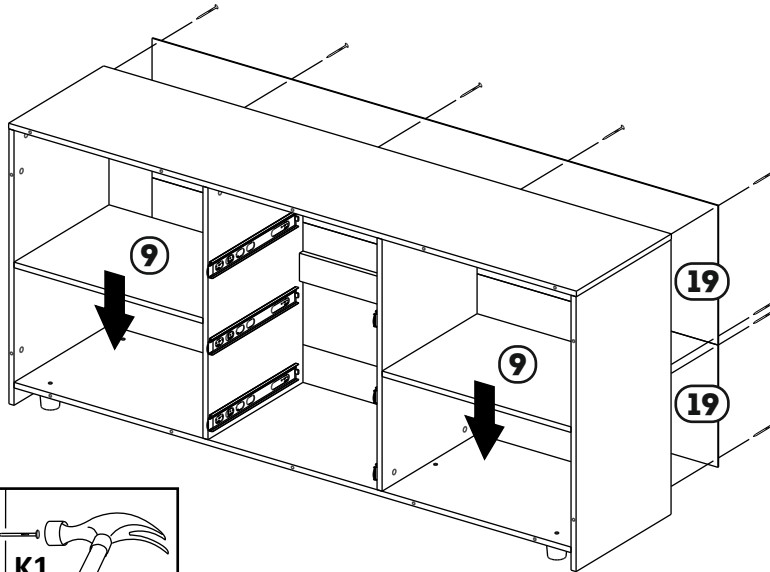



**7**

Dowel

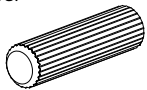

x4

C1

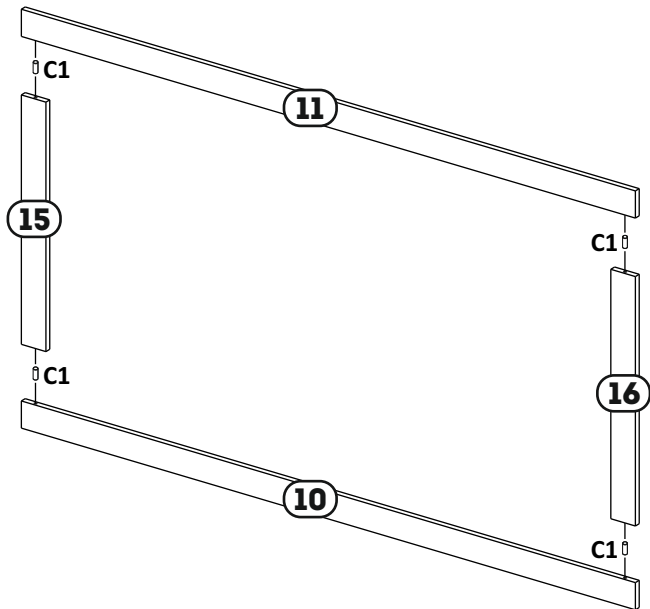
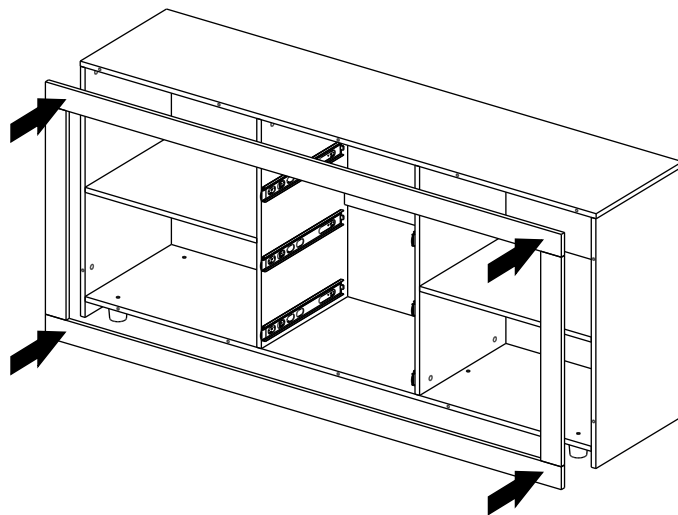
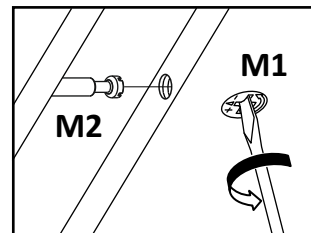
**8**

9

Confirmat

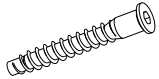

x8

A1

Cap for confirmate

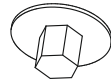

x8

A2

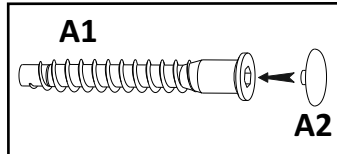
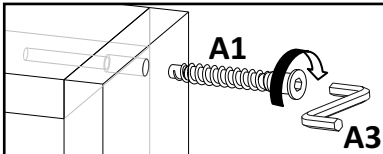
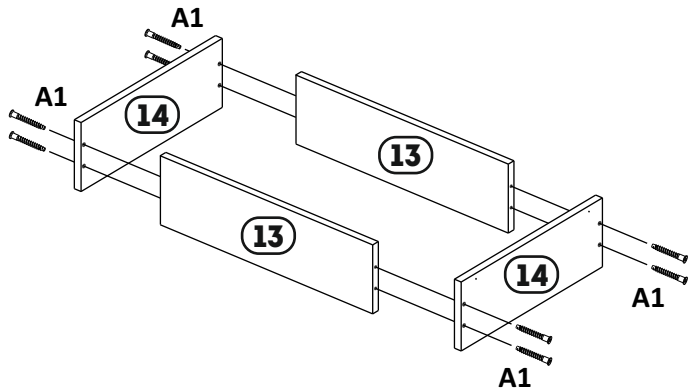

10

Nail  
1x16

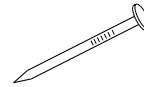

x12

K1

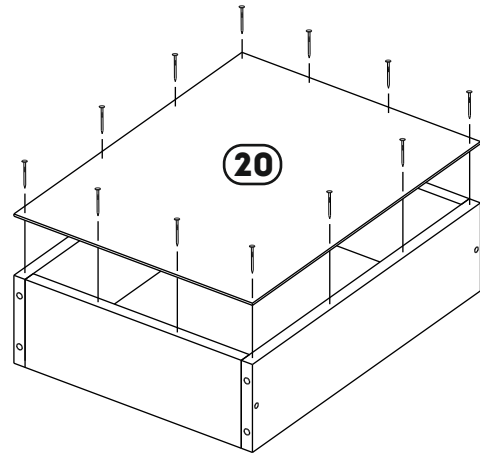
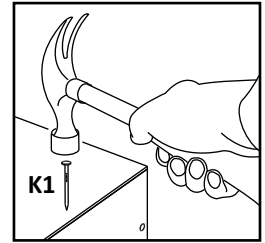

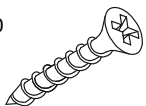
**11**Screw  
3,5x30**x4****W3**

Dowel

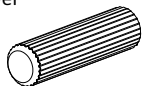
**x4****C1**

Handle

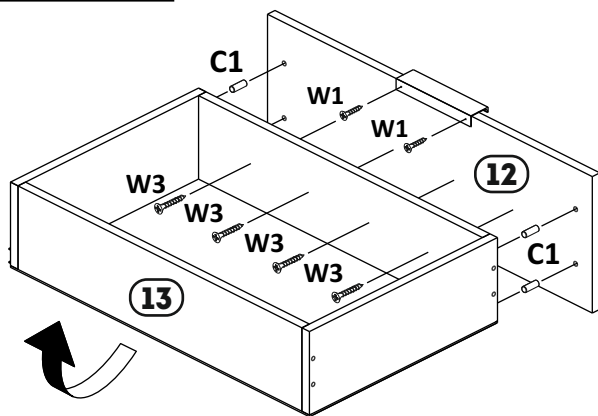
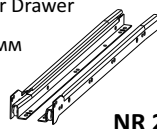
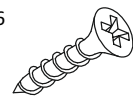
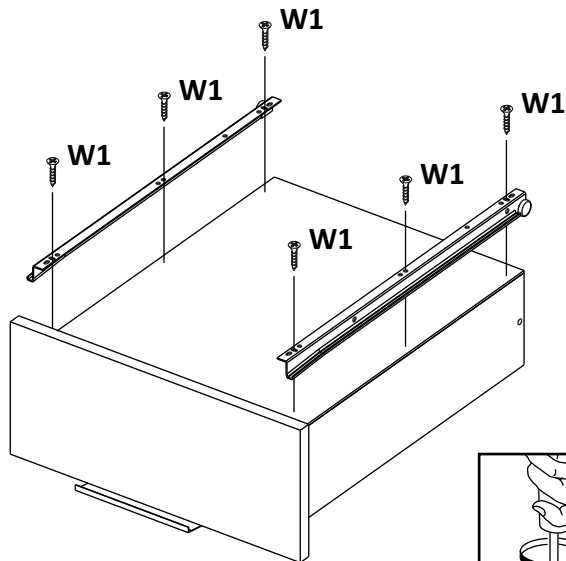
**x1****RK 1****12**Roller Drawer  
Slide  
400 MM**x3****NR 2**Screw  
3,5x16**x6****W1**

# 13

90 Degree Hinge

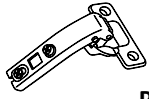

x4

P9

Screw  
3,5x16

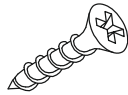

x12

W1

Handle



x2

RK 1

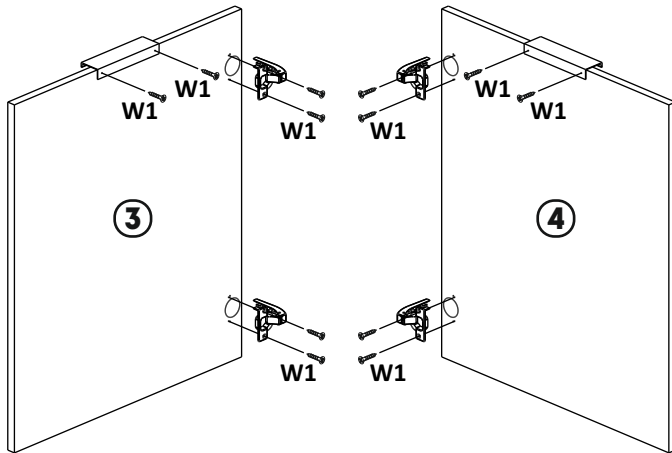

# 14

