

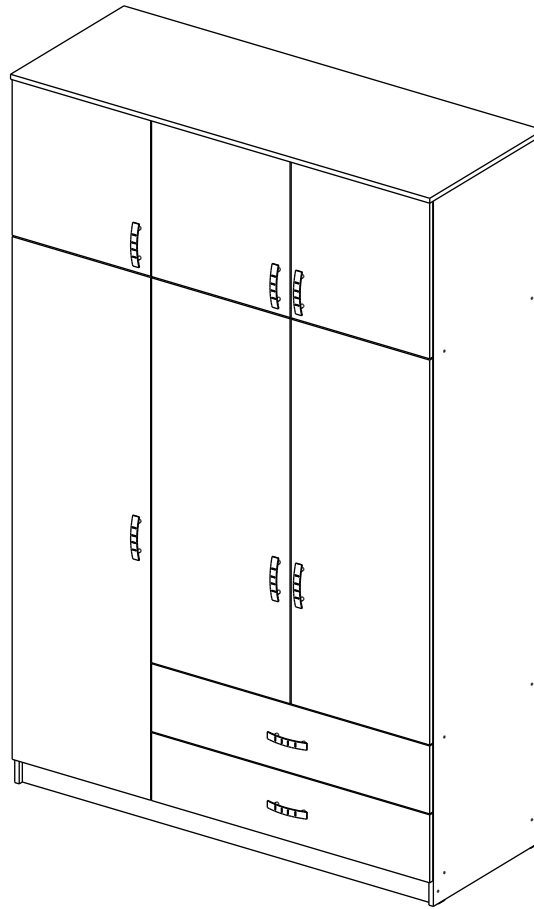

361-000068

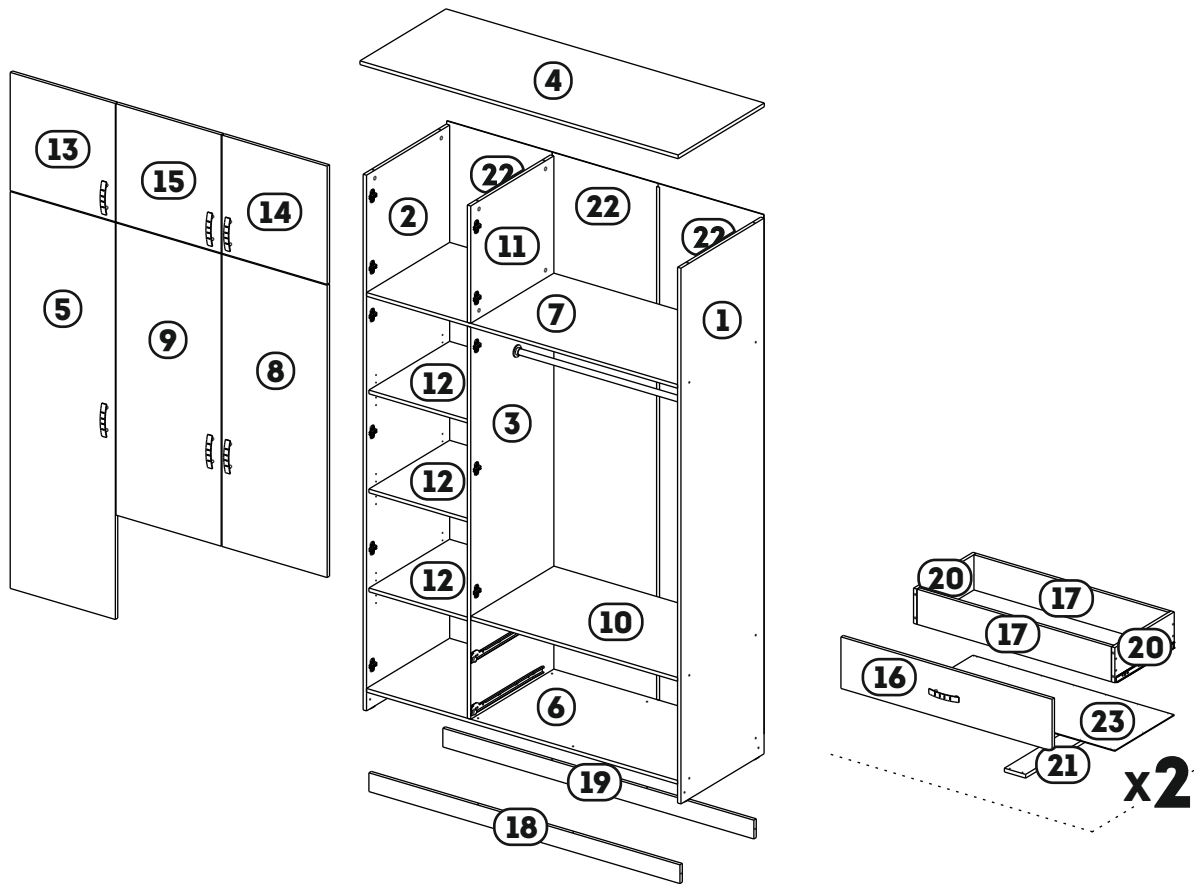



No	a*b	X	Pack
1	2284x560	1	1
2	2284x560	1	1
3	1672x560	1	4
4	1501x580	1	3
5	1692x496	1	2
6	1467x560	1	3
7	1467x560	1	4
8	1246x496	1	2
9	1246x496	1	2
10	976x560	1	4
11	500x560	1	4
12	476x544	3	5
13	504x496	1	5
14	504x496	1	5
15	504x496	1	5
16	220x996	2	3
17	918x150	4	3
18	1467x80	1	3
19	80x1467	1	3
20	400x150	4	2
21	100x400	2	2
22	2216x498	3	1
23	950x400	2	1

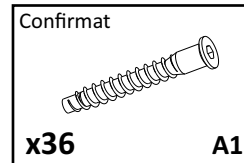
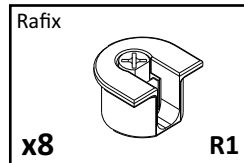
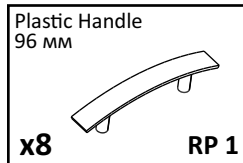
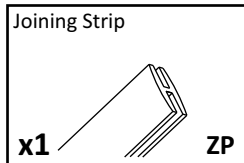
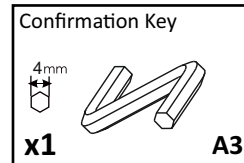
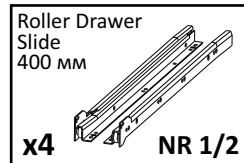
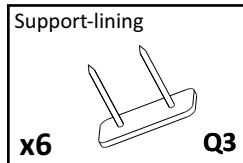
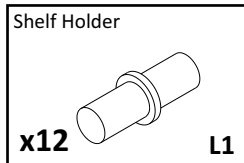
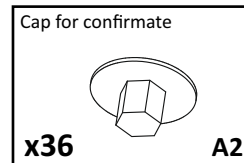
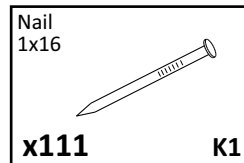
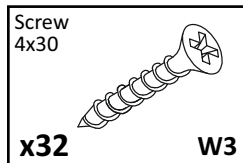
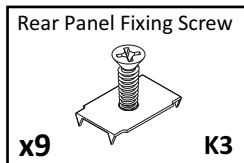
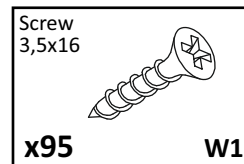
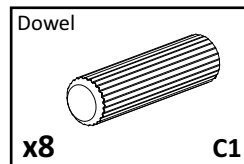
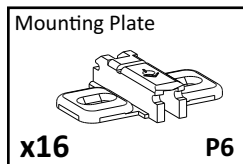
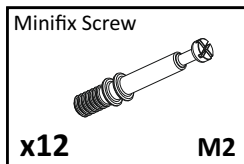
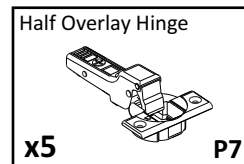
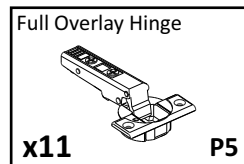
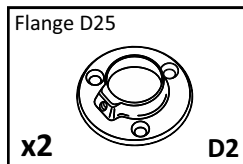
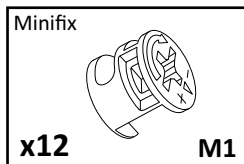

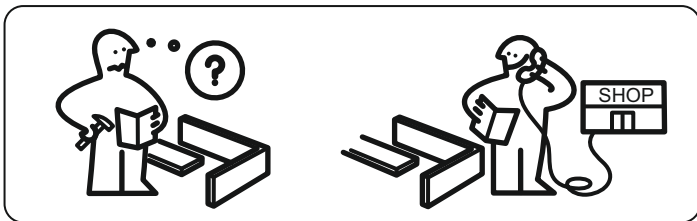
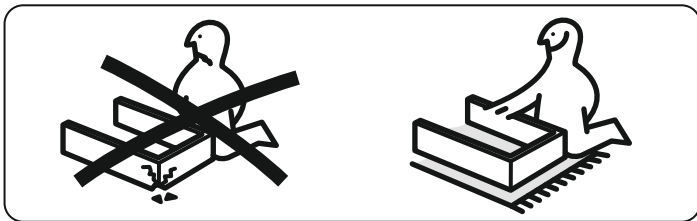
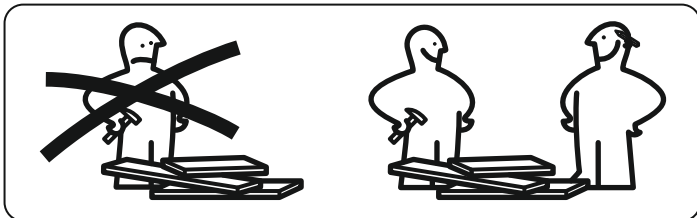

## GENERAL TECHNICAL INSTRUCTIONS FOR FURNITURE ASSEMBLY

- CHECK COMPATIBILITY OF PARTS AND ACCESSORIES BEFORE ASSEMBLY.
- FOR FURNITURE ASSEMBLY, WE RECOMMEND USING THE SERVICES OF QUALIFIED SPECIALISTS.
- DO ASSEMBLY ON A SURFACE COVERED WITH CLOTH OR CARDBOARD TO PREVENT SCRATCHES.

## CARE AND MAINTENANCE OF FURNITURE

- KEEP THE FURNITURE FROM PROLONGED CONTACT WITH WATER OR HOT STEAM.
- ENSURE SUFFICIENT DISTANCE FROM ELECTRICAL APPLIANCES AND HEATERS.
- IF THERE IS DIRTY ON THE FURNITURE, REMOVE IT WITH A DAMP CLOTH AND THEN WIPE IT DRY. DO NOT USE ABRASIVE MATERIALS.

# 1

Mounting Plate

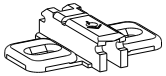

x16

P6

Roller Drawer Slide  
400 mm

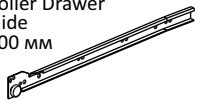

x4

NR 1

Minifix



x12

M1

Screw  
3,5x16

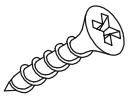

x12

W1

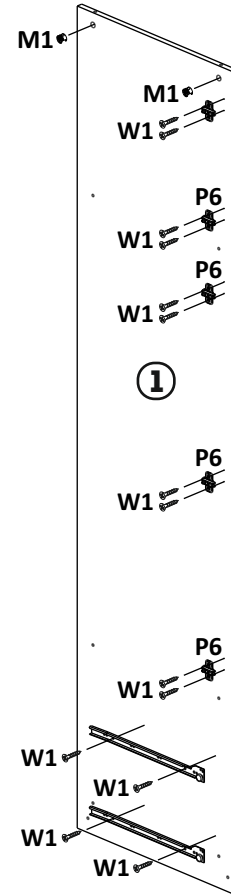
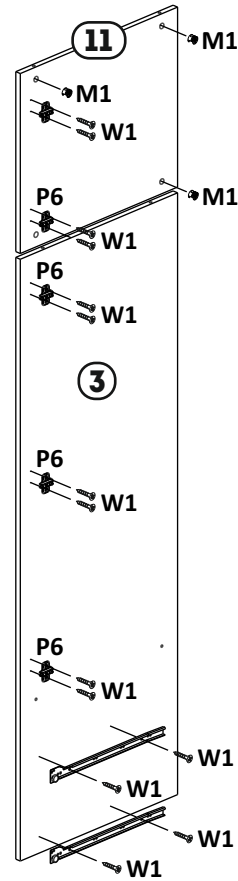
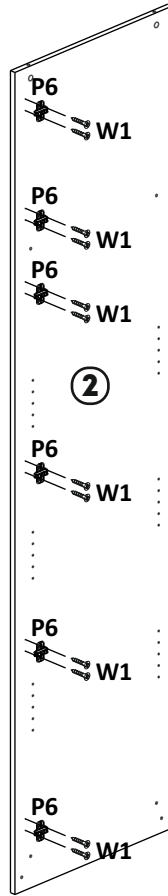
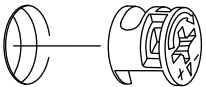

**2**

Confirmat

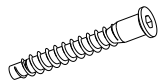
**x4****A1**

Minifix Screw

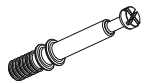
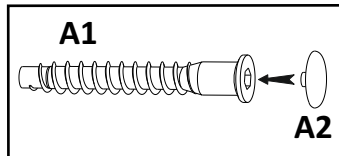
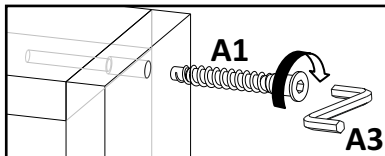
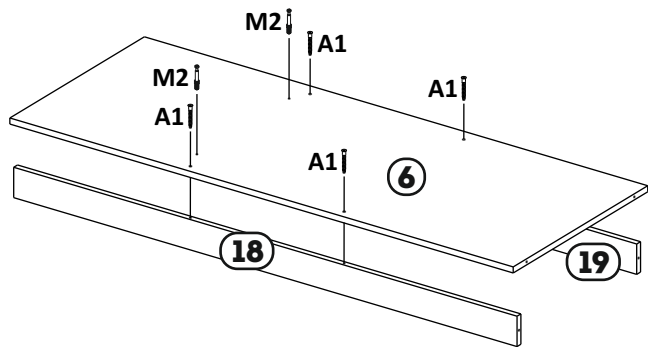
**x2****M2****3**

Confirmat

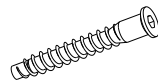
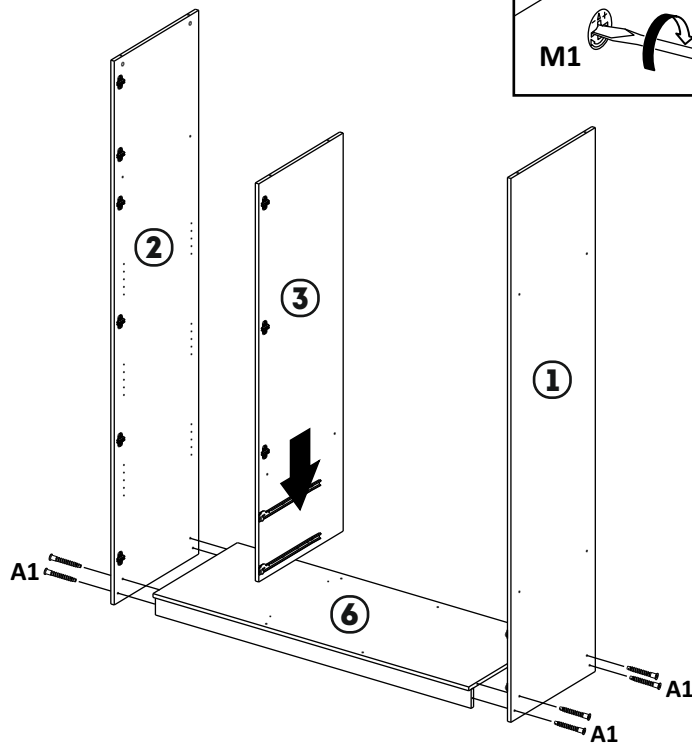
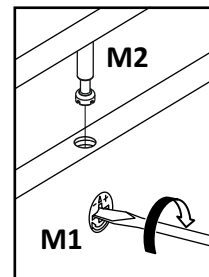
**x8****A1**

4

Minifix Screw

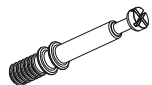

x4

M2

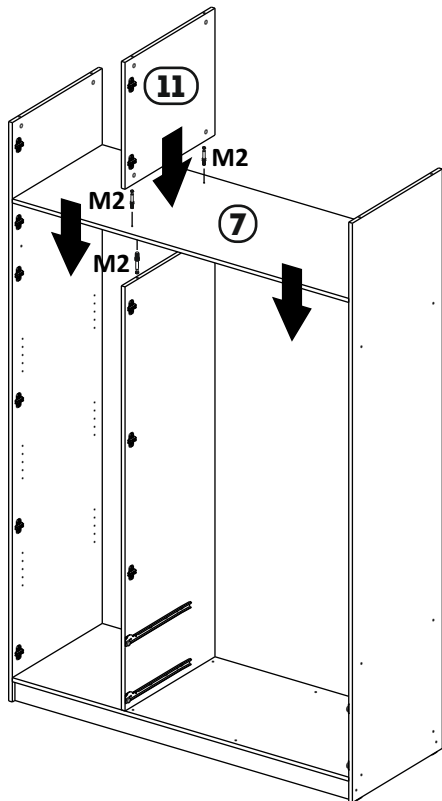
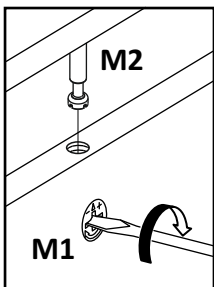

5

Minifix Screw

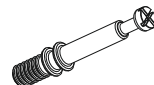

x6

M2

Confirmat

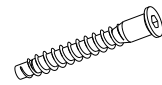

x8

A1

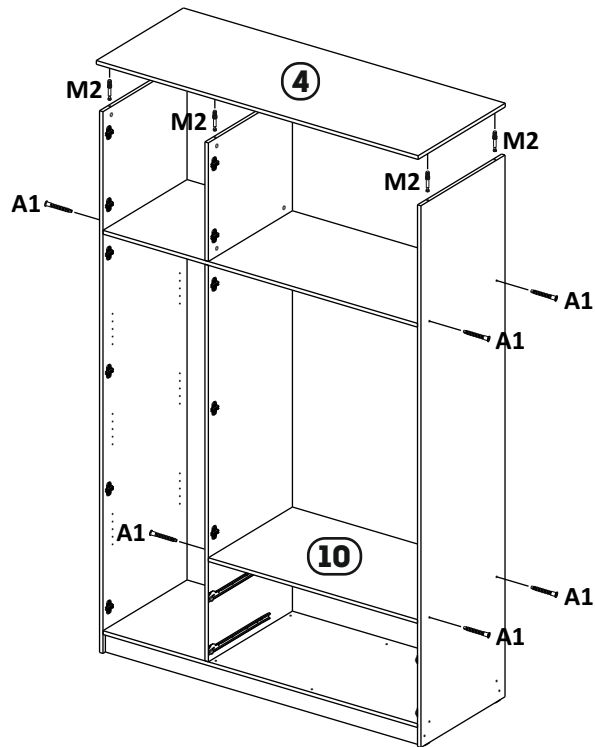

**6**

Rear Panel Fixing Screw

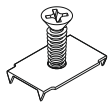

x9

K3

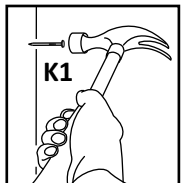
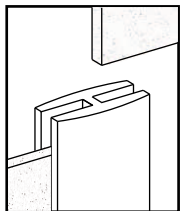

K1

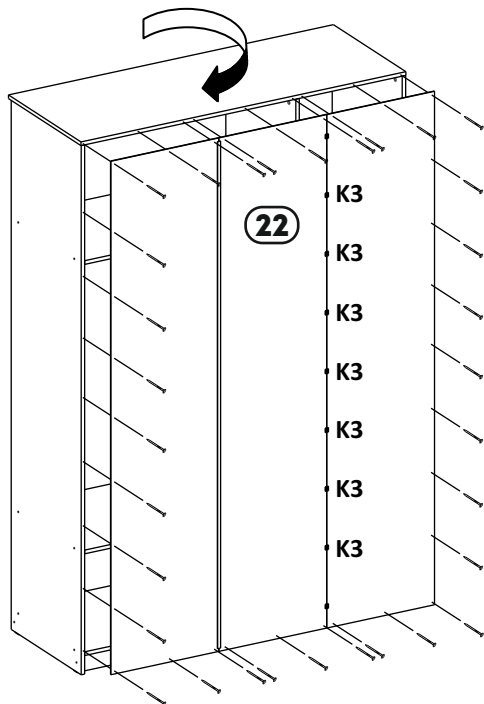
**7**

Confirmat

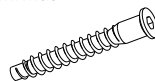

x8

A1

Cap for confirmate

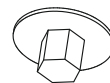

x8

A2

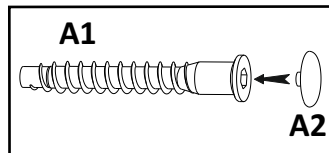
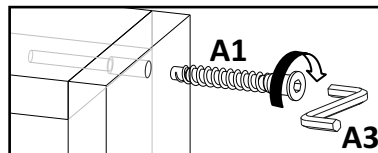
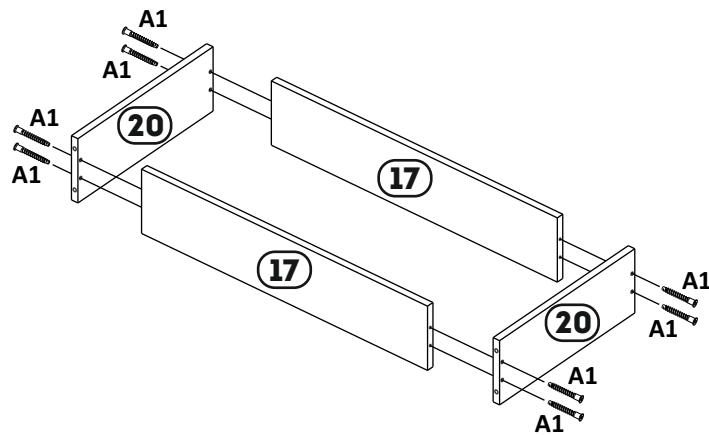

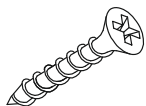
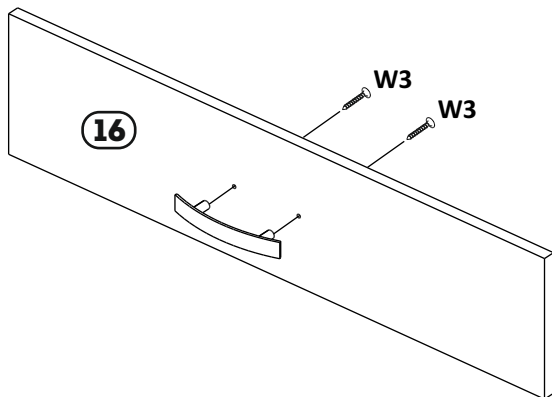

**8**Screw  
4x30**x4****W3**Plastic Handle  
96 mm**x2****RP 1****9**

Dowel

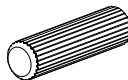
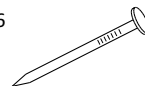
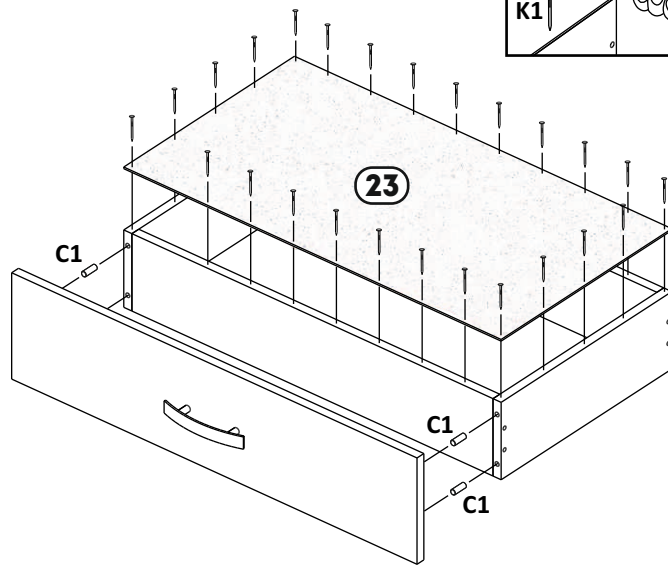
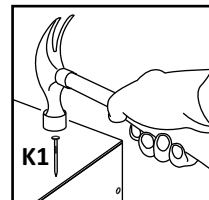
**x4****C1**Nail  
1x16**x26****K1**

# 10

Roller Drawer  
Slide  
400 mm

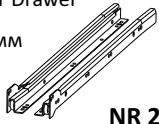

x1

NR 2

Screw  
3,5x16

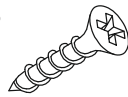

x4

W1

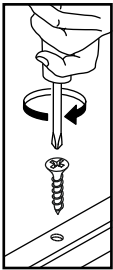
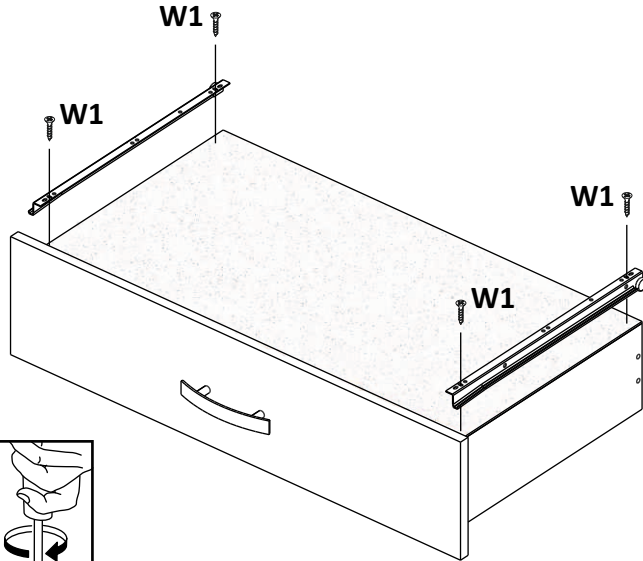

# 11

Screw  
4x30

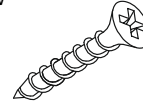

x4

W3

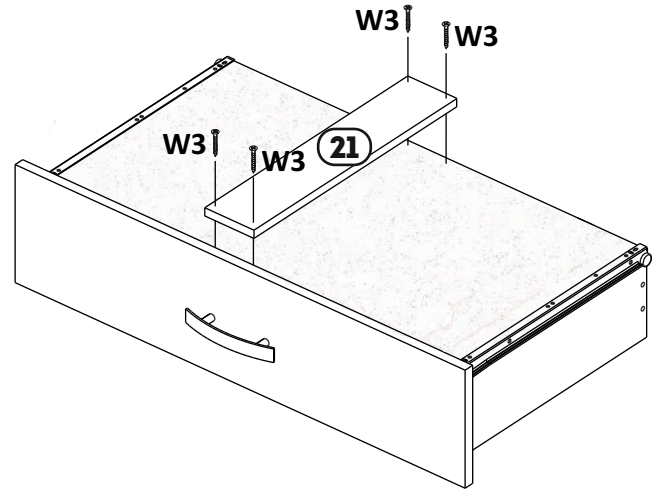

# 12

Screw  
3,5x30

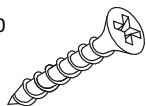

x4

W3

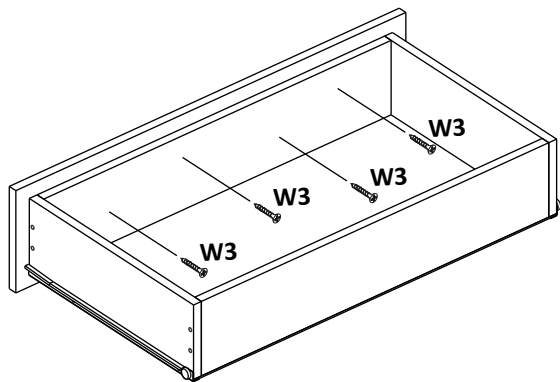

# 13

Full Overlay Hinge

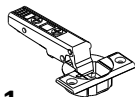

x11

P5

Half Overlay Hinge

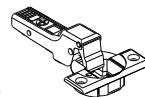

x5

P7

Screw  
3,5x16

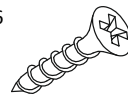

x12

W1

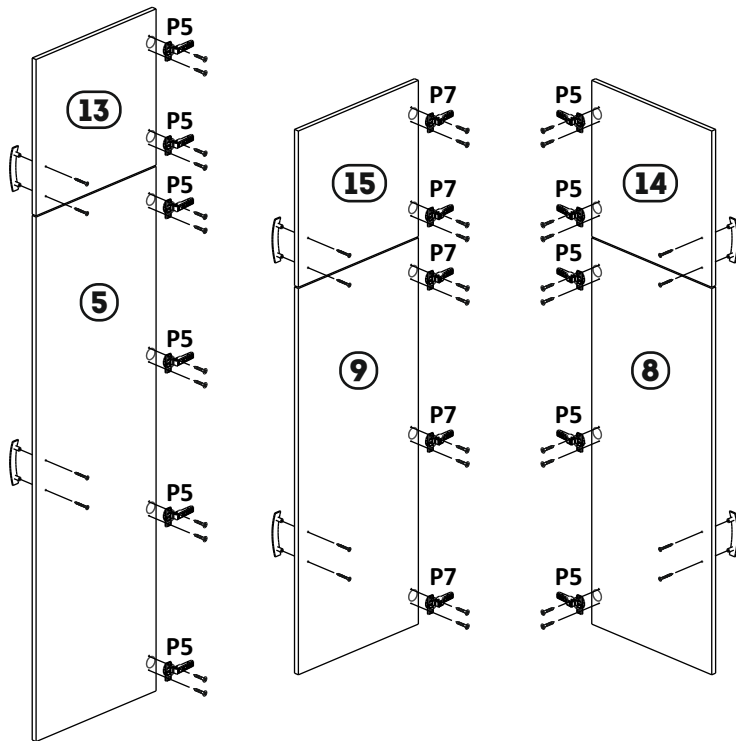

14

