

No	a*b	X	Pack
1	2200x520	1	5/5
2	2166x500	1	5/5
3	1984x500	1	3/5
4	1984x500	1	3/5
5	1888x500	1	4/5
6	1888x500	1	4/5
7	1900x436	3	1/5
7	1900x436	2	2/5
8	855x500	2	4/5
9	424x500	4	4/5
10	2166x80	2	5/5
11	1916x438	5	3/5

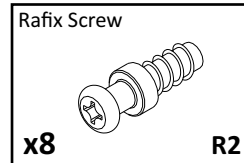

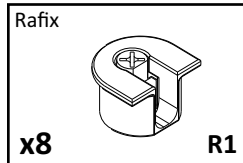
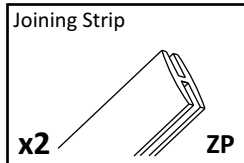
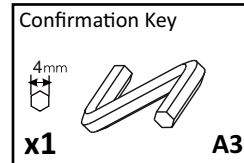
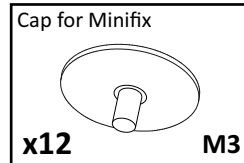
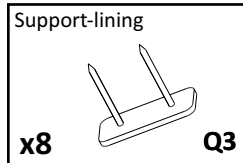
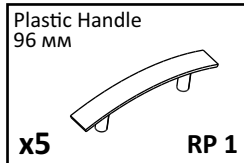
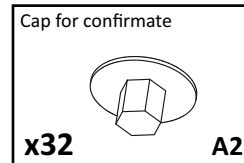
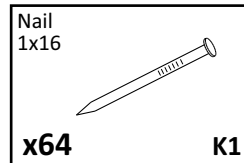
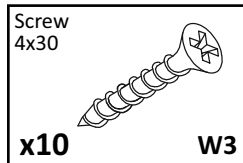
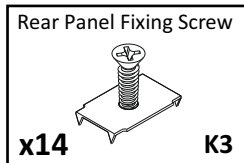
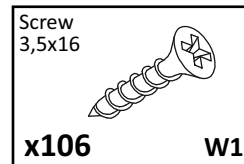
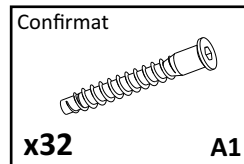
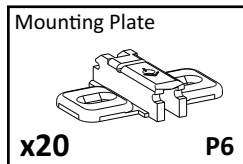
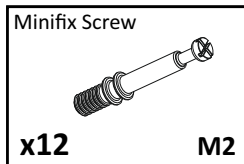
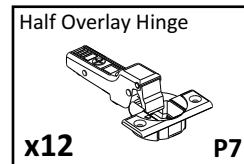
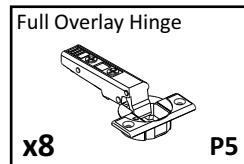
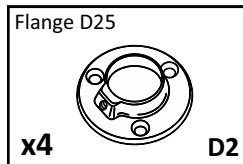
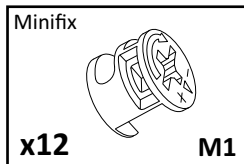
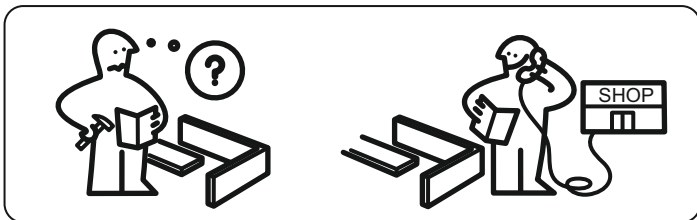
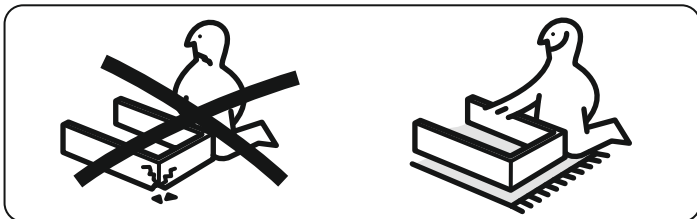
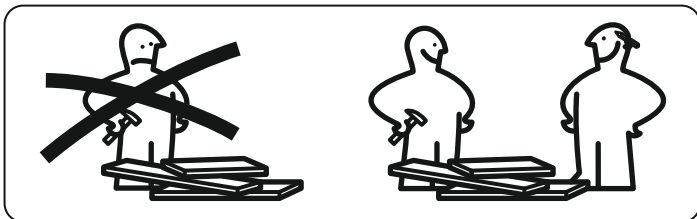

GENERAL TECHNICAL INSTRUCTIONS FOR FURNITURE ASSEMBLY

- CHECK COMPATIBILITY OF PARTS AND ACCESSORIES BEFORE ASSEMBLY.
- FOR FURNITURE ASSEMBLY, WE RECOMMEND USING THE SERVICES OF QUALIFIED SPECIALISTS.
- DO ASSEMBLY ON A SURFACE COVERED WITH CLOTH OR CARDBOARD TO PREVENT SCRATCHES.

CARE AND MAINTENANCE OF FURNITURE

- KEEP THE FURNITURE FROM PROLONGED CONTACT WITH WATER OR HOT STEAM.
- ENSURE SUFFICIENT DISTANCE FROM ELECTRICAL APPLIANCES AND HEATERS.
- IF THERE IS DIRTY ON THE FURNITURE, REMOVE IT WITH A DAMP CLOTH AND THEN WIPE IT DRY. DO NOT USE ABRASIVE MATERIALS.

1

Mounting Plate

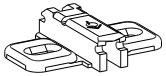

x20

P6

Rafix Screw

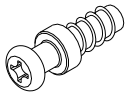

x8

R2

Minifix



x12

M1

Screw
3,5x16

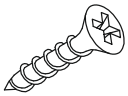

x40

W1

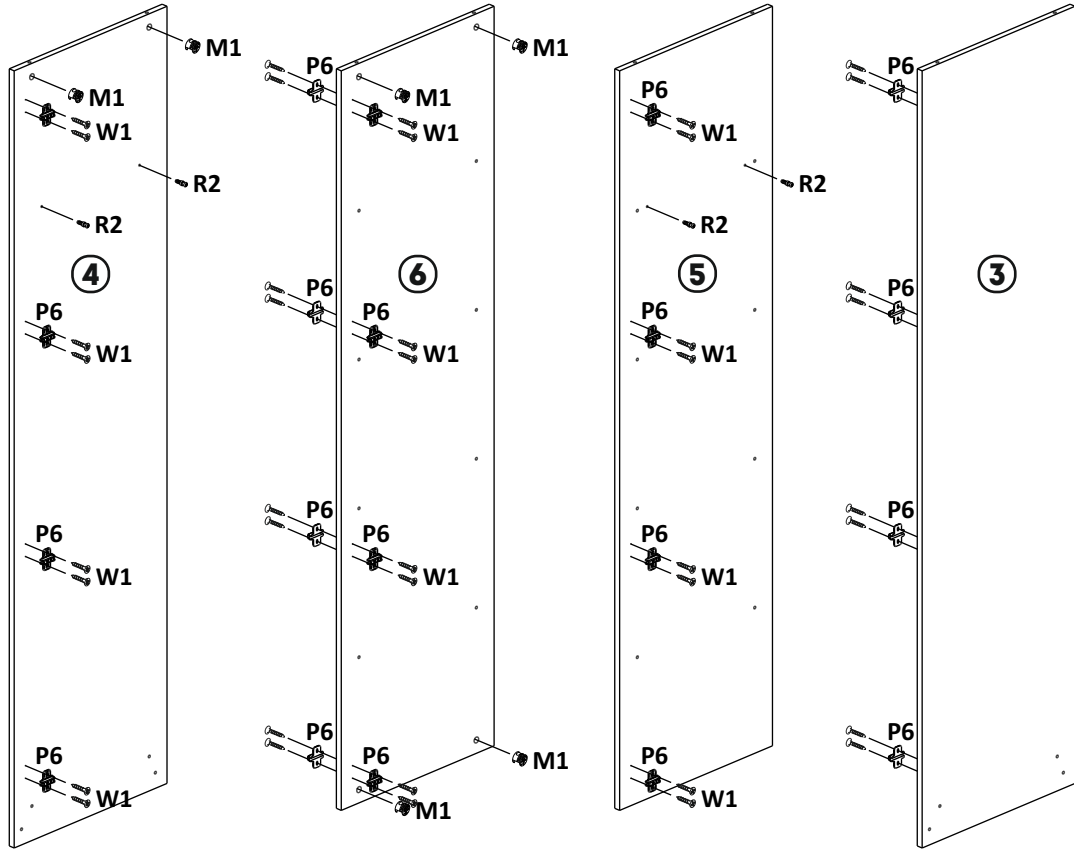
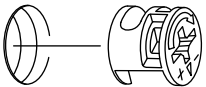

2

Confirmat

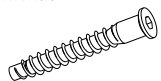

x8

A1

Minifix Screw

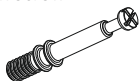

x4

M2

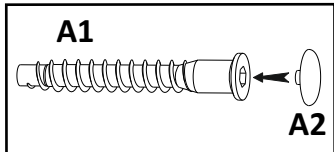
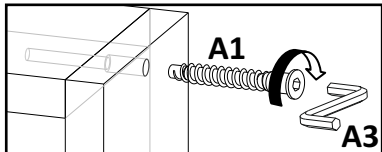
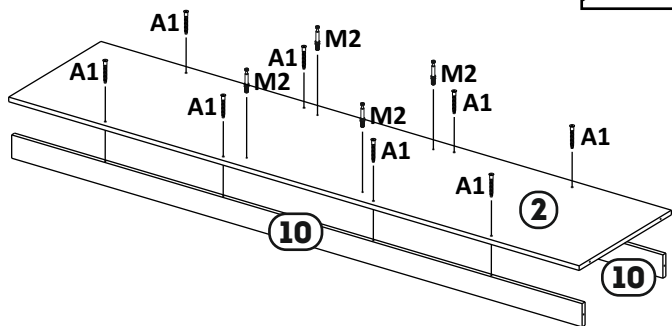
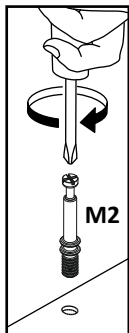

3

Confirmat

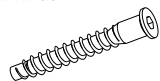

x16

A1

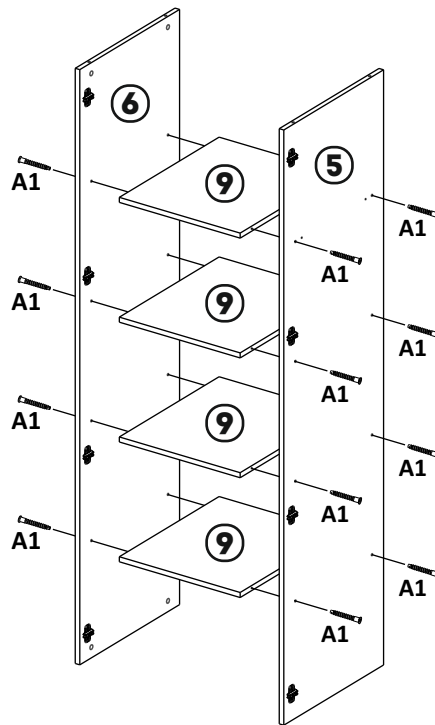

4

Confirmat

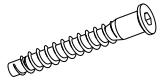

x8

A1

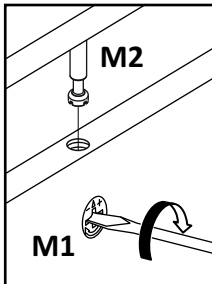

M1

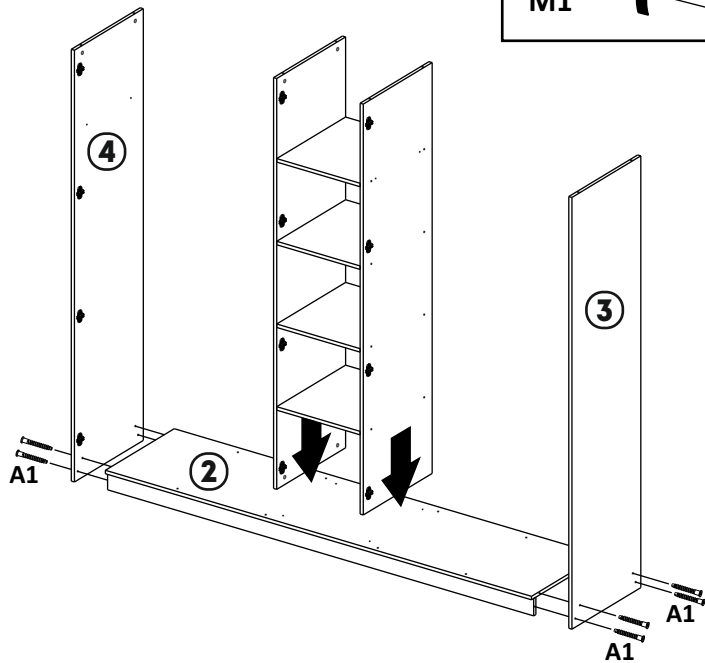
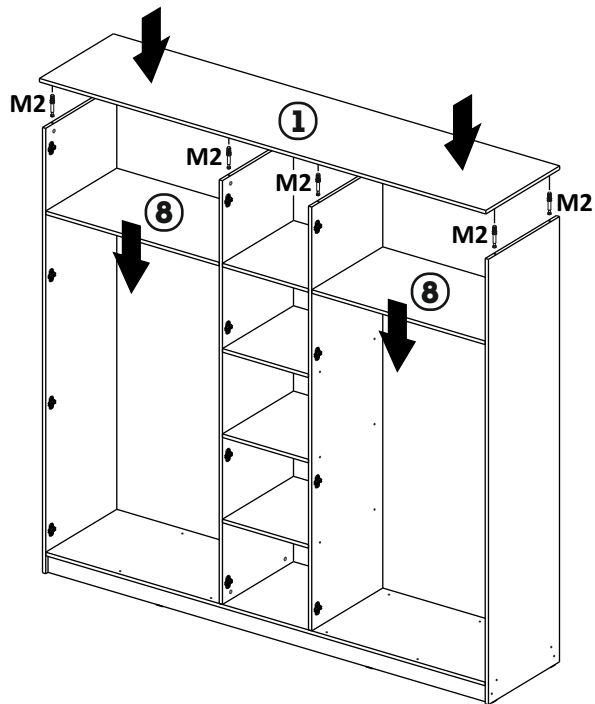
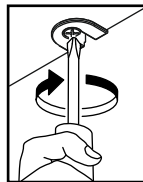
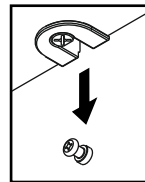
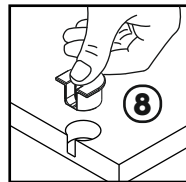
**5**

6

Rear Panel Fixing Screw

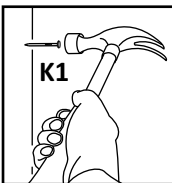
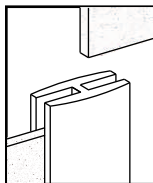
**x14****K3****K1****7**

Full Overlay Hinge

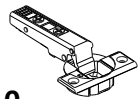
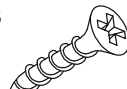
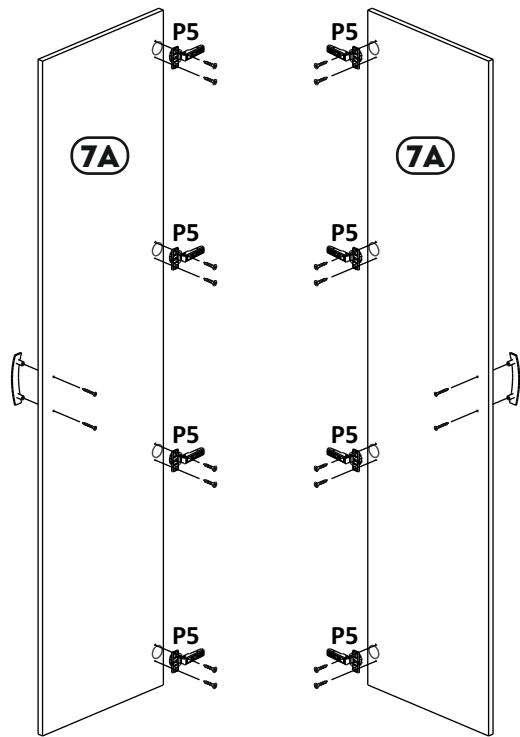
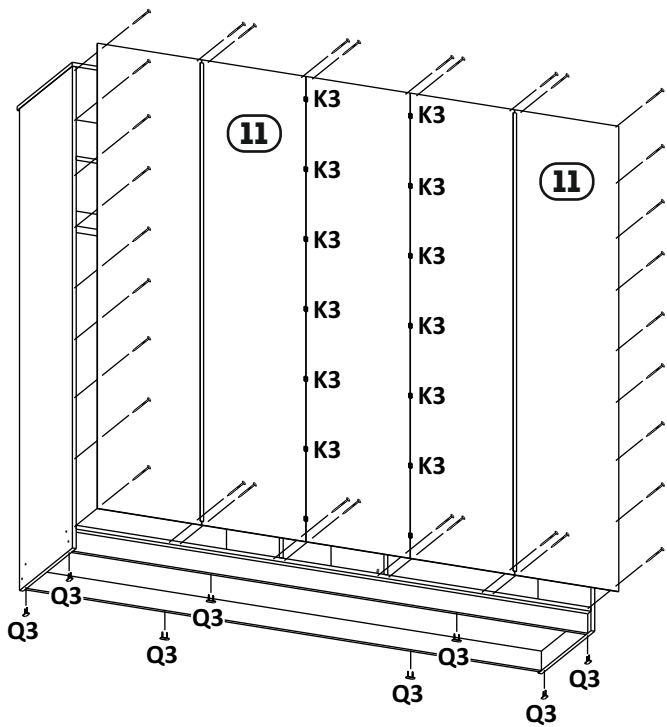
**x10****P5**Screw
3,5x16**x20****W1**

8

Half Overlay Hinge

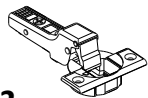
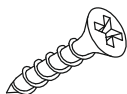
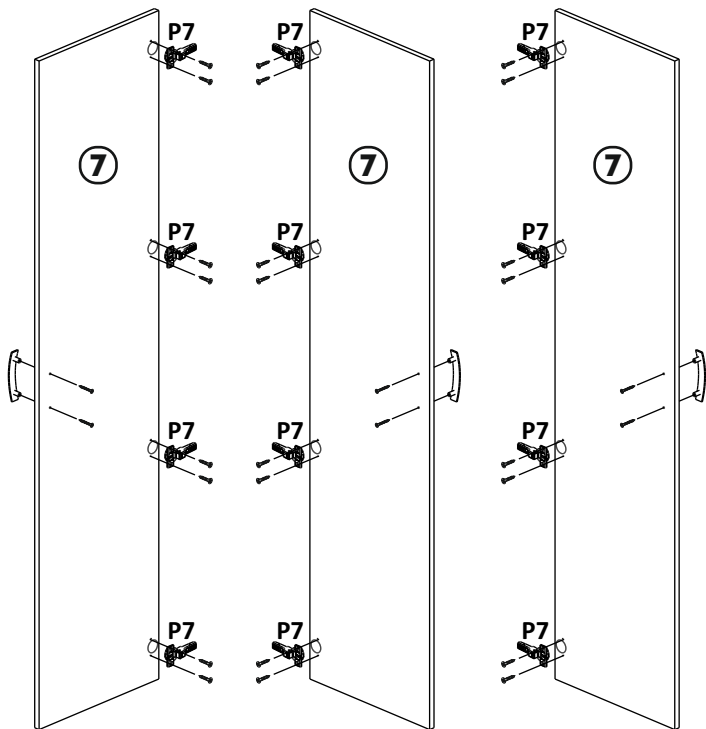
**x12****P7**Screw
3,5x16**x24****W1****9**