

Assembly instruction

275-000003

PARTES

a



b



c

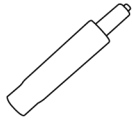

d



e

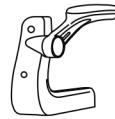

2pcs

f

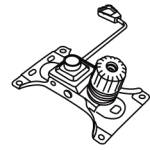

i



5pcs

h

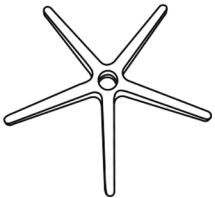

j

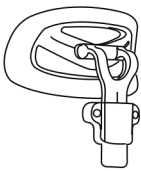

l



4pcs

6×30mm

m



4pcs

6×20mm

n



6pcs

6×25mm

1

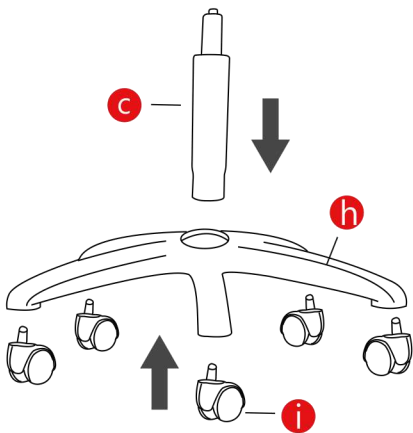

2

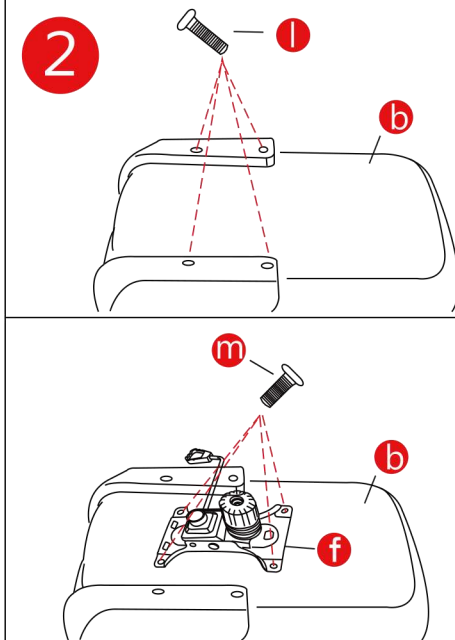

3

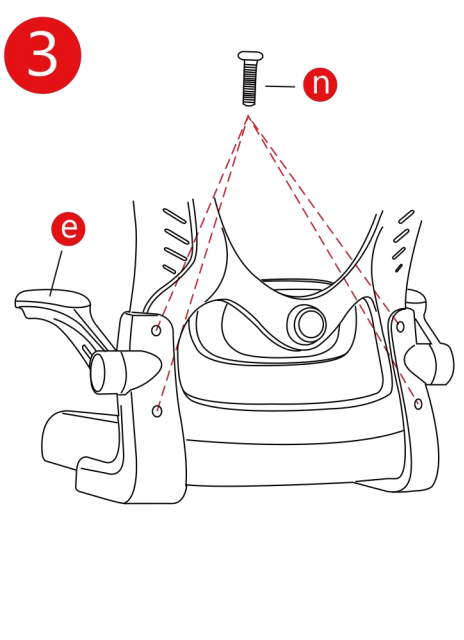

4

