

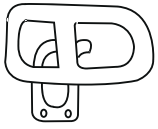









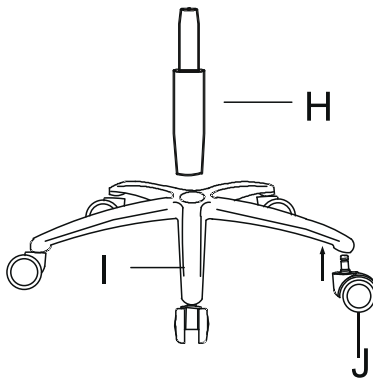
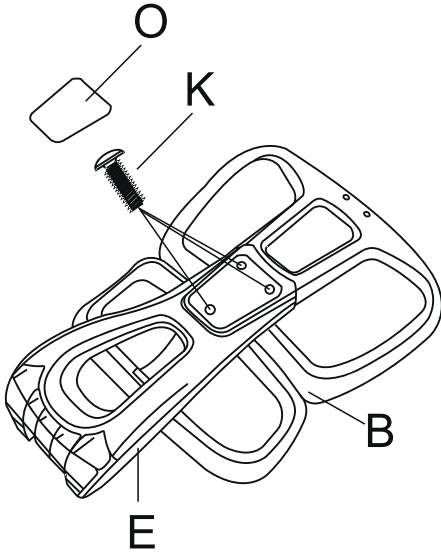
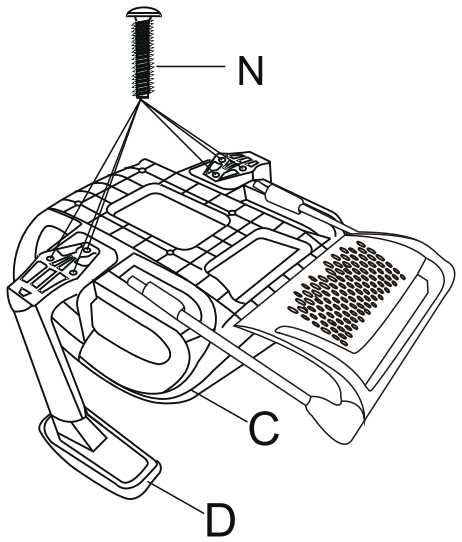



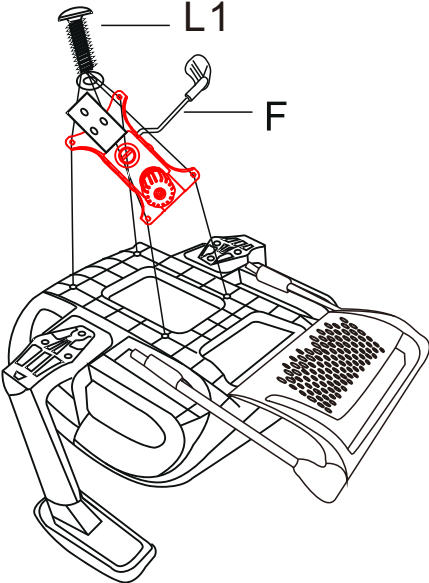
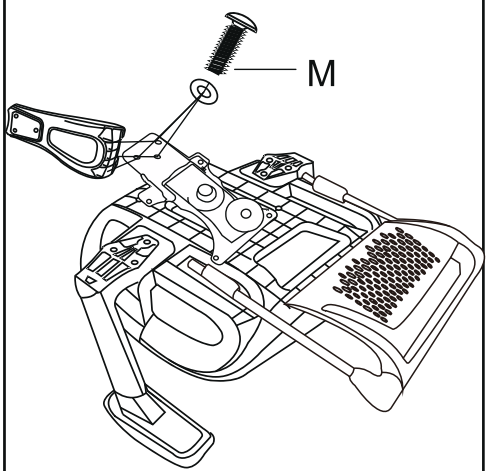
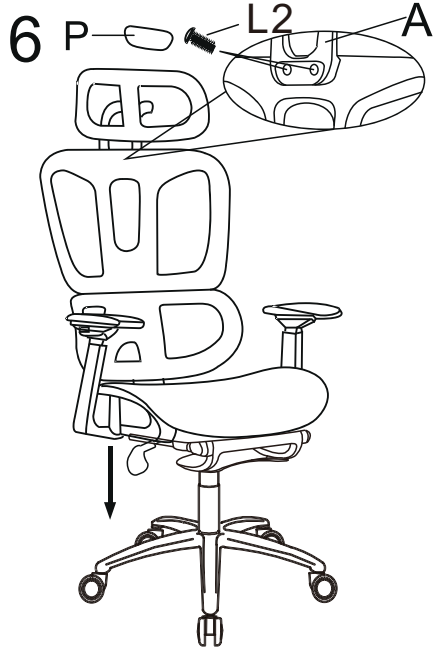

ASSEMBLY INSTRUCTIONS 256-000002

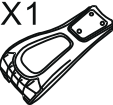
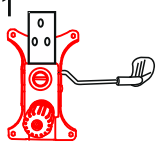
(A) X1 	(I) X1 	1 	2 	3 
(B) X1 	(J) X5 			
(C) X1 	(K) X3 (M6*25mm) 	4 	5 	6 
(D) X2 	(L1) X4 (M6*20mm)   (L2) X2 (M6*20mm) 			
(E) X1 	(M) X3 (M8*25mm)  			
(F) X1 	(N) X6 (M6*30mm) 			
(H) X1 	(O) X1 			
	(P) X1 			
	(Q) X1 