

P2M1

Before starting the assembly need to



1 person



Phillips screwdriver



Hammer



Drill

Dear Customer

This product you have purchased has been subjected to all tests and controls by us before it reaches you. However, your product may have been damaged during transportation or shipped incompletely. Therefore, it is useful to check the current product using the manual before starting the installation. If you encounter a missing or faulty object during the check, define the object using the manual and contact our company. Our office will provide you with the object you need as soon as possible. You do not need to return the faulty product to our company.

For a successful installation, please provide the auxiliary tools mentioned above.

Before you start, clean every existing item with a damp cloth.

After cleaning the existing parts, arrange them in a suitable area according to the size. Meanwhile, be careful not to rub against each other while moving the pieces and not to hit the corner parts while arranging them.

During installation, carefully review all steps in the manual.

After the installation process is completed, check the integrity of all connection points.

After the assembly, carry the product as 2 people.

Do not expose your product to direct sunlight. Keep away from hot and humid environments. Position your product appropriately considering these issues. In addition, do not load the product with heavy loads that may cause stretching and do not use it outside of its purpose.

You can contact our company about the topics you are curious about.

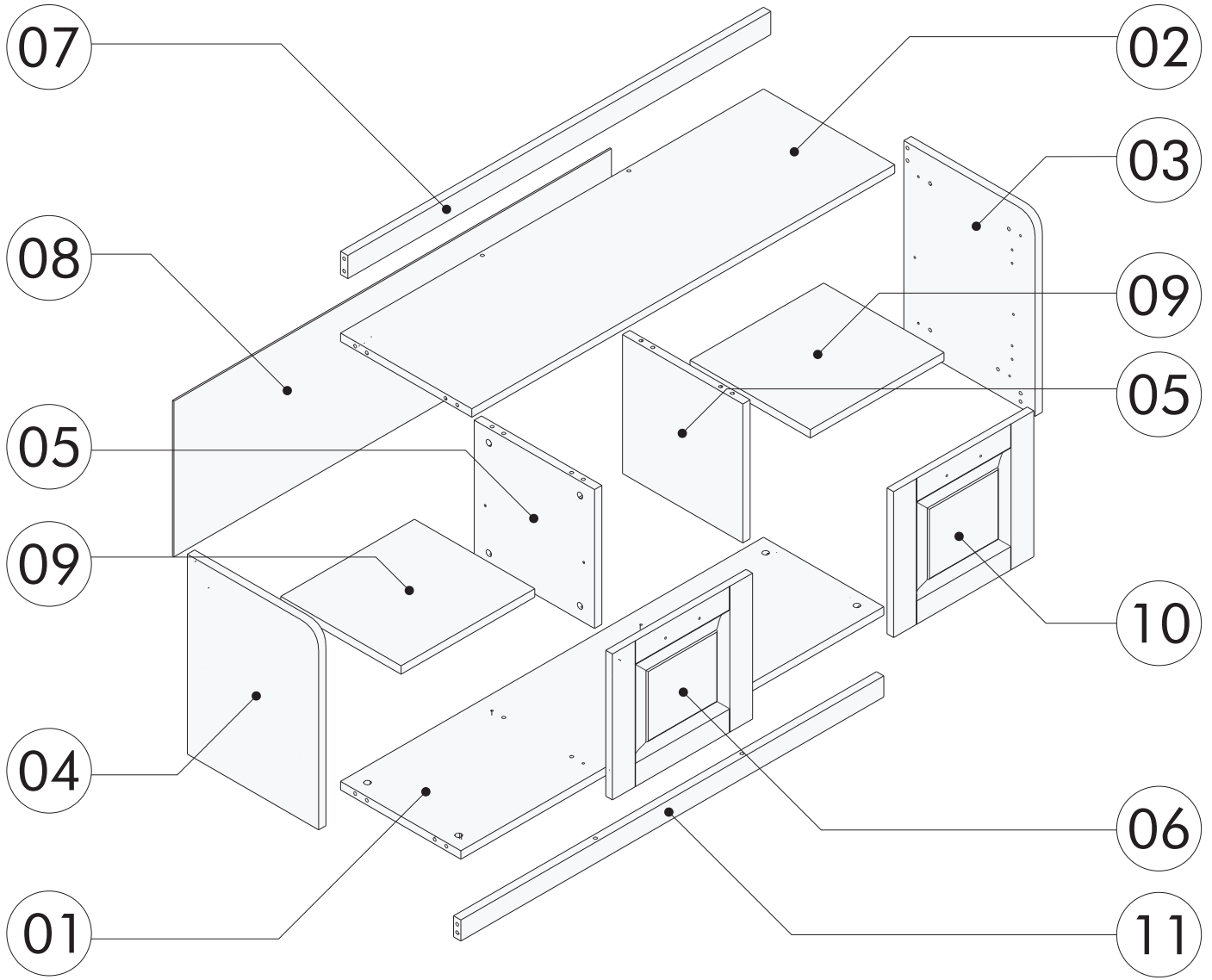

LIST OF PART

LIST OF ACCESSORY

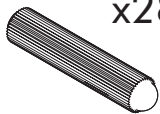
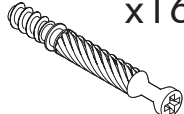
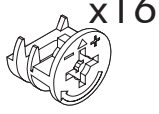
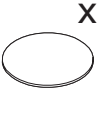
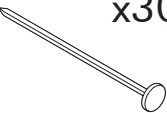
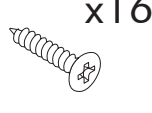
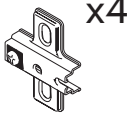
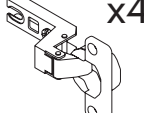
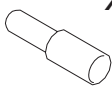
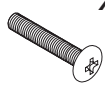
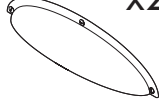
Code	Dimension	Pieces	LIST OF ACCESSORY			
01	116.4 x 37 x 1.8 cm	1	 x28	 x16	 x16	 x16
02	116.4 x 40 x 1.8 cm	1	A01 Kavela	A02 Mil	A03 Gövde	A09 Tapa
03	45 x 40 x 1.8 cm	1				
04	45 x 40 x 1.8 cm	1	 x30	 x16	 x4	 x4
05	37 x 31.4 x 1.8 cm	2	A05 Arkalık Çivisi	A06 3.5x18	A12 Menteşe Taban	A15 Ment Tam Deve
06	38.4 x 33 x 1.8 cm	1				
07	116.4 x 5 x 1.8 cm	1	 x8	 x4	 x2	
08	119.7 x 34.5 x 0.3 cm	1	A10 Raf Pimi	A11 Kulp Vidası	A79 Kulp	
09	37 x 37 x 1.8 cm	2				
10	38.4 x 33 x 1.8 cm	1				
11	116.4 x 5 x 1.8 cm	1				

