

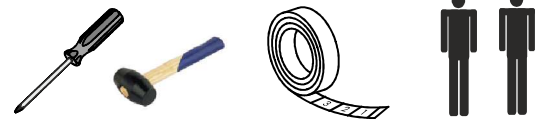

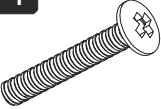

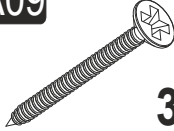

# LAURA STUDY TABLE CT2

## ASSEMBLY MANUAL

### ACCESSORY LIST

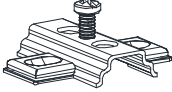

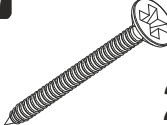
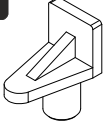
<b>A14</b>  <b>2x</b>	<b>A09</b>  <b>35 x</b>	<b>A10</b>  <b>8x</b>	<b>A16</b>  <b>20x 4x</b>	<b>A24</b>  <b>1x</b>
<b>A12</b>  <b>2x</b>	<b>A13</b>  <b>2x</b>	<b>A28</b>  <b>20x</b>	<b>A77</b>  <b>2x</b>	<b>A23</b>  <b>12x</b>

### GENERAL VIEW

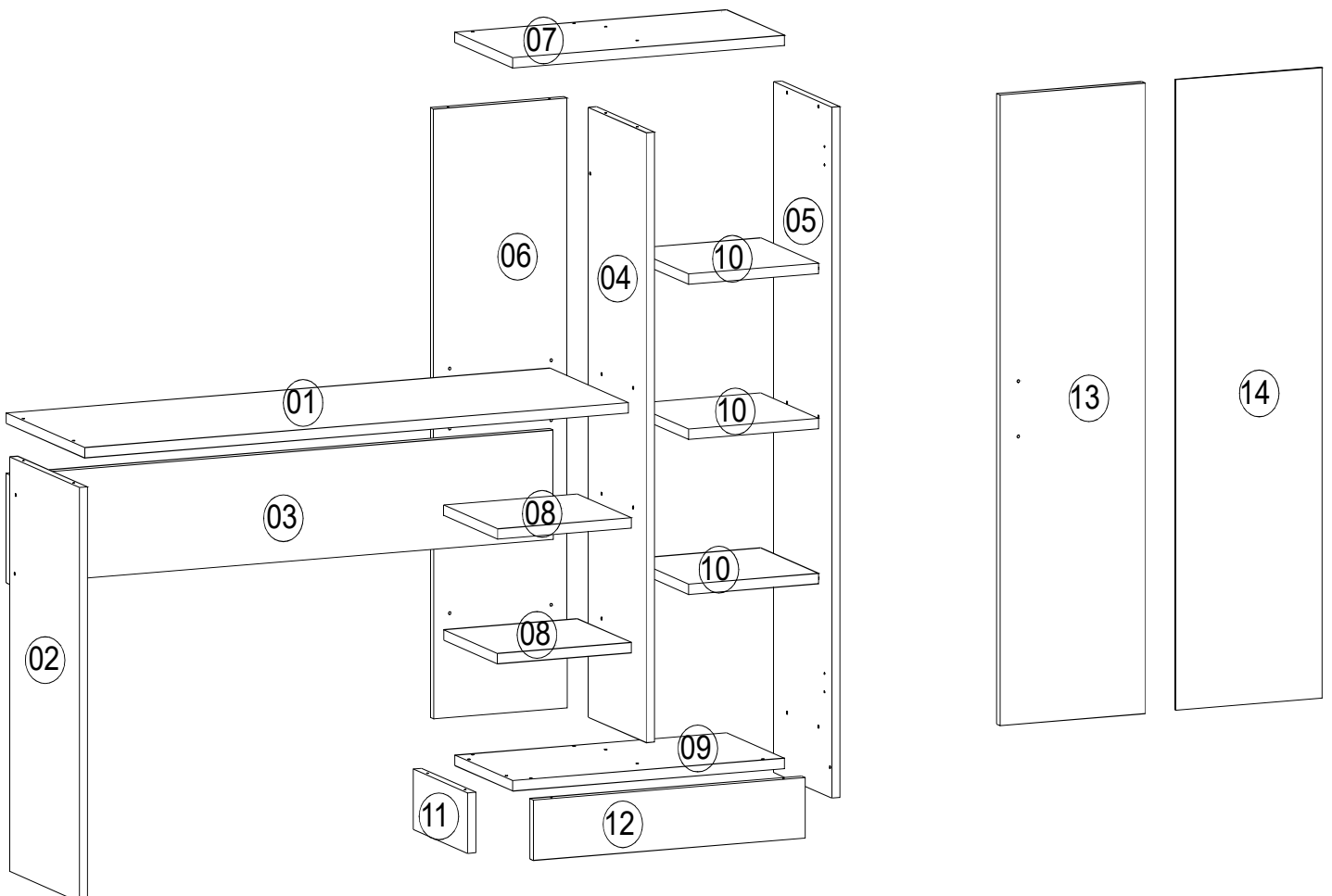

# ASSEMBLY MANUAL

