























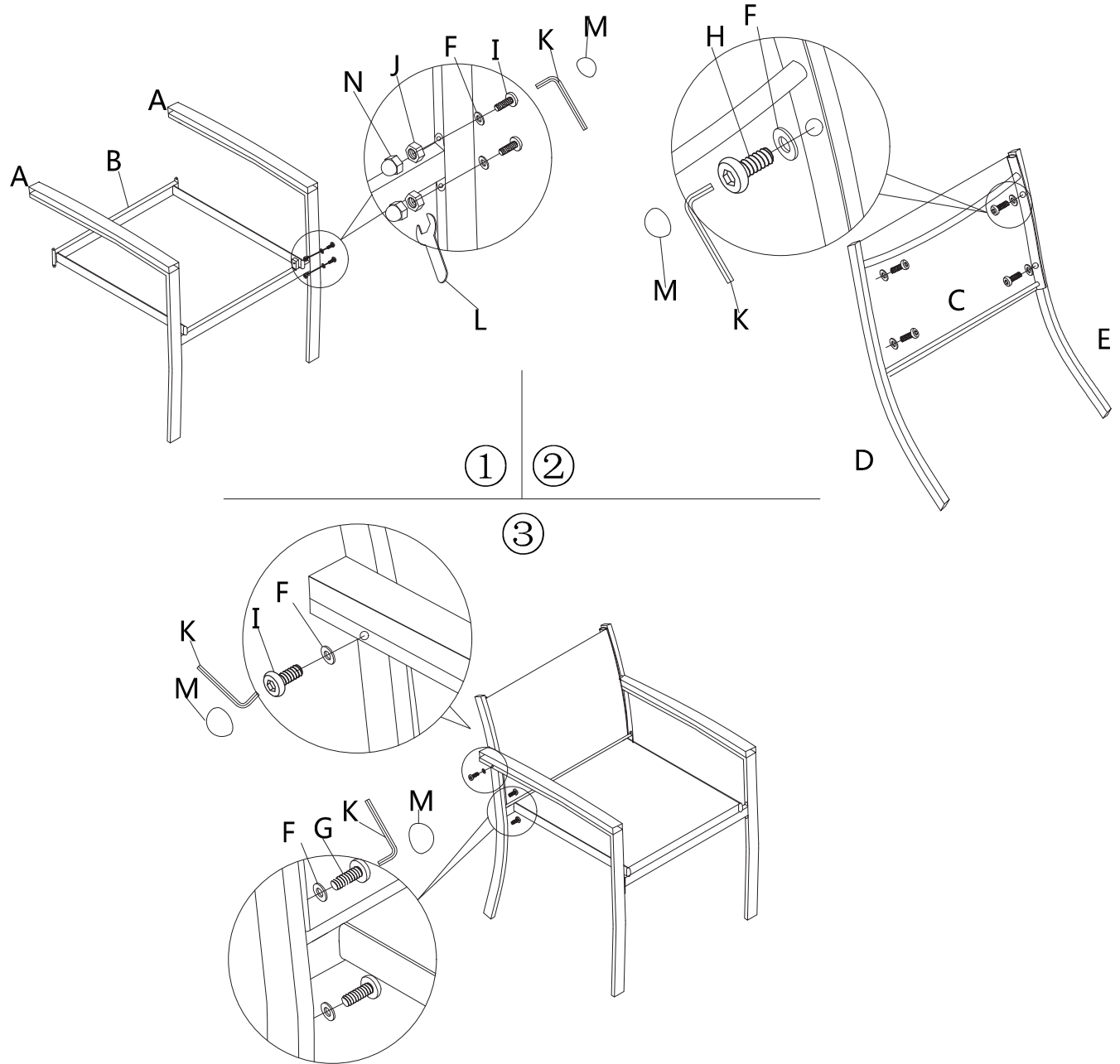







# ASSEMBLING INSTRUCTION









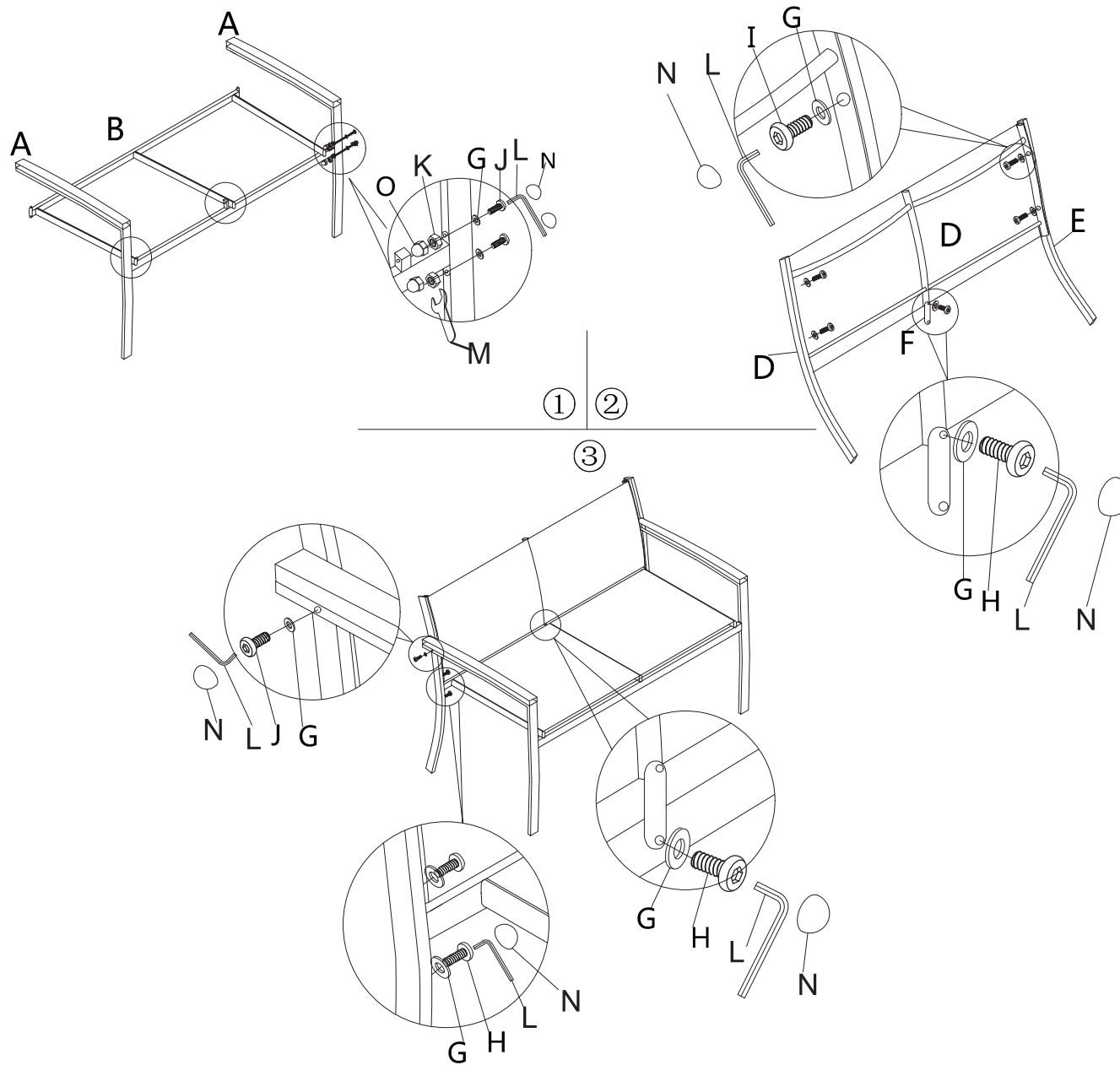

NO.	PARTS LIST	QTY PCS
A		2
B		1
C		1
D		1
E		1
F	 φ12xφ6.5x1.0	14
G	 M6x15	4
H	 M6x25	4
I	 M6x50	6
J		4
K		1
L		1
M		14
N		4



NO.	PARTS LIST	QTY PCS
A		2
B		1
C		1
D		1
E		1
F		1
G	 φ12xφ6.5x1.0	16
H	 M6x15	6
I	 M6x25	4
J	 M6x50	6
K		4
L		1
M		1
N		16
O		4



<b>A</b>		<b>2</b>
<b>B</b>		<b>2</b>
<b>C</b>		<b>1</b>
<b>D</b>		<b>6</b>
<b>E</b>	 Ø 12*Ø6.5*1.0	<b>8</b>
<b>F</b>	 M6*13	<b>8</b>
<b>G</b>		<b>1</b>
<b>H</b>		<b>8</b>

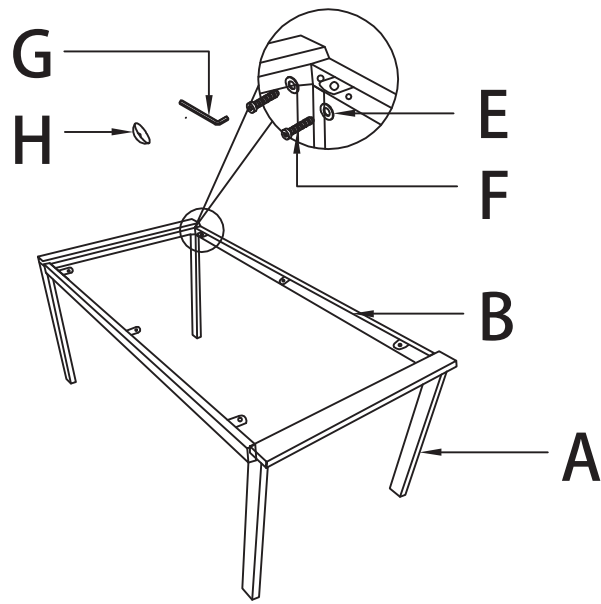

①

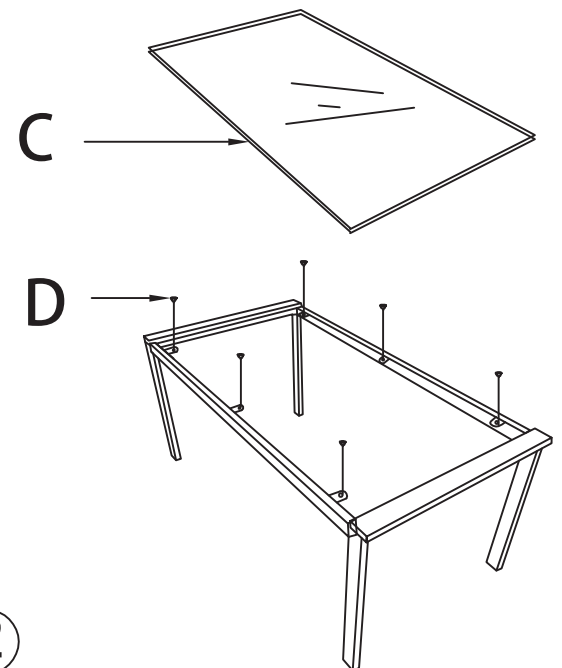

②

③

