

120-000380

Sideboard

Assembly Instruction

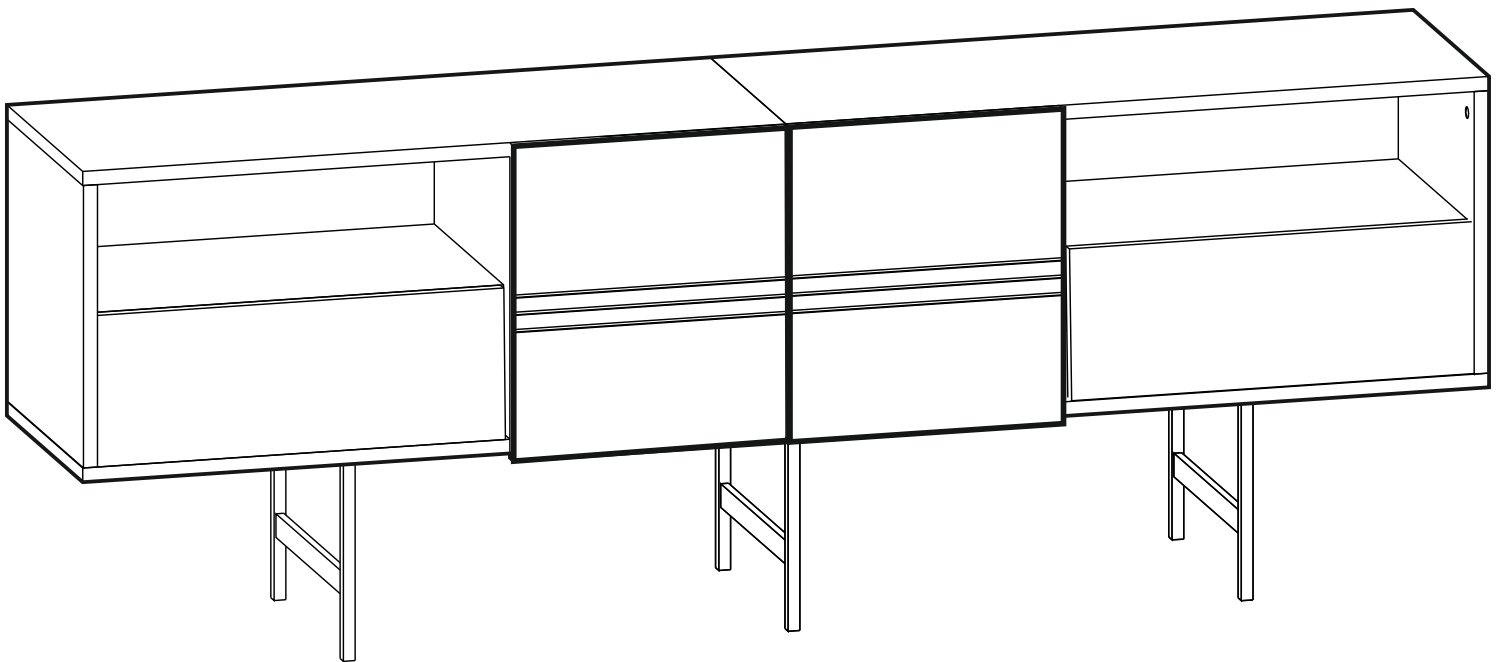



Valued Customer,

We design and carefully manufacture our products for our customers, We wish that our customers to have fun while they are doing their new furniture

The product you just purchased was subjected to all sorts of tests and controls before sending out to you.

Hope you enjoy your new furniture.



Before starting, please check all components and accessories according to the provided list. If you purchased more than one product, to prevent confusion, be sure that you completed the first product, then start the next one. Please make sure that you select correct numbered part and use specific connector to assemble. We do not recommend any modification or rotation in assembly. Please follow the manual carefully.



Furniture parts are going to several manufacturing procedures. During this process, parts can have little dust or marks. Please clean the parts with damp cloth before assembly to get the best result. Usual cleaning would be suffice.



Although all products are carefully manufactured and packed, sometimes we experience damage during transportation. In such cases, please check the damaged part, note the part number written on the part and do not hesitate to contact us



Do not use your furniture for out of purposes. If you would like to use it out of purpose or would like to do some modification or rotation, please contact us for more details.

Please do not expose your furniture with excessive heat, cold and humidity because product can be affected negatively.

If you need your product to mount on the wall, Please use suitable rawlplug for your wall type. We send you rawlplugs suitable for concrete and brick walls.

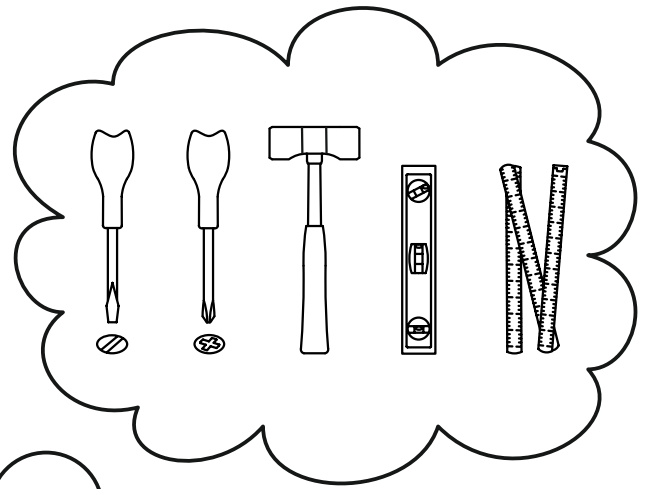
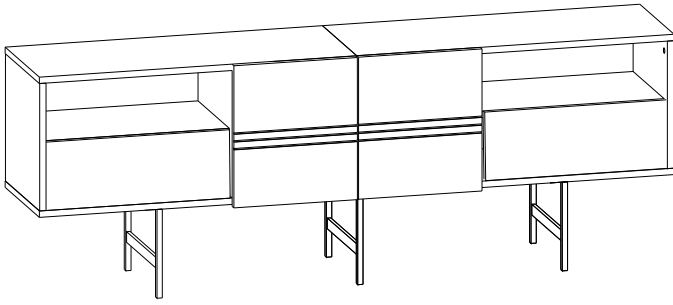

Part#1	1x
Part#2	1x
Part#3	1x
Part#4	1x
Part#5	2x
Part#6	1x
Part#7	1x
Part#8	1x
Part#9	1x
Part#10	1x
Part#11	1x
Part#12	1x
Part#13	1x
Part#14	2x

Disassembled Parts

TOTAL 16

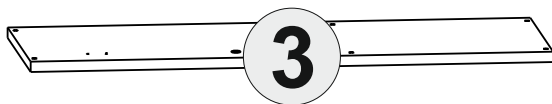
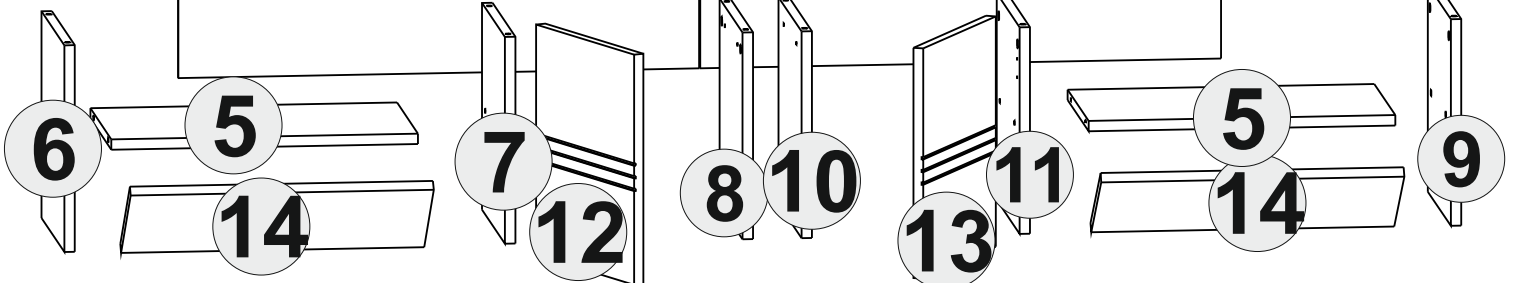
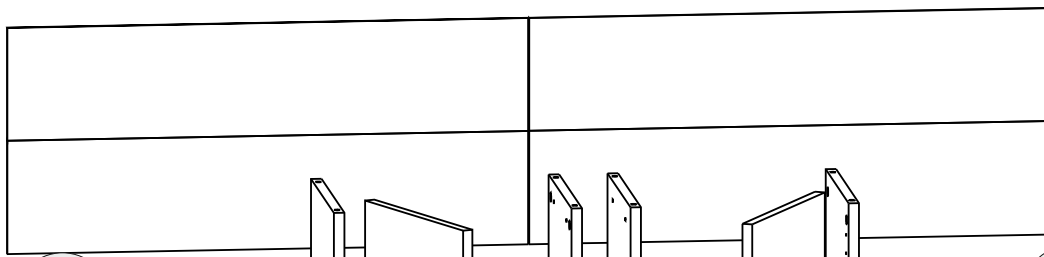
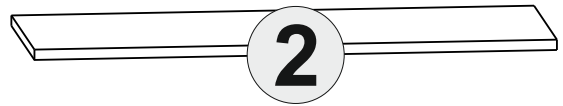
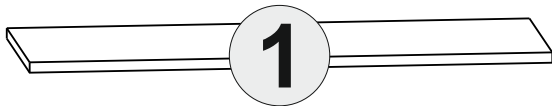

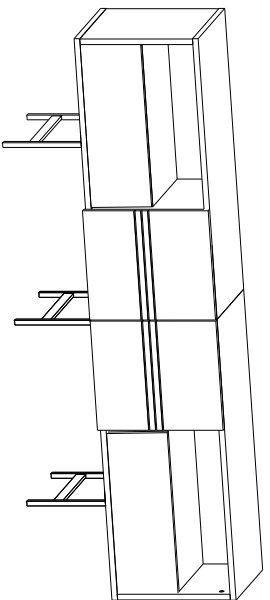

Tools & Installation Components

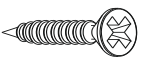

A19 3,5x18 screw

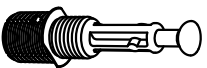

A23 Q10 minifix screw



A02 15x14 minifix head



A17 6x50 screw

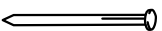

A28 nail

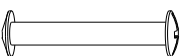

A06 mounting screw

50X

16X

16X

20X

30X

4X

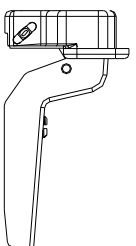

C02 inset hinge

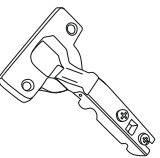

C01 hinge base

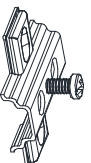

C04 hinge mounting plate



Q12 sticker



Q15 sticker

4X

4X

8X

4X

10X

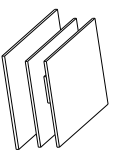

15X15 plastic

6X



Please be aware that C01, C02 and C04(pivot) parts may come as attached together.

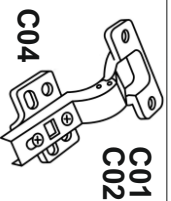

Step 1

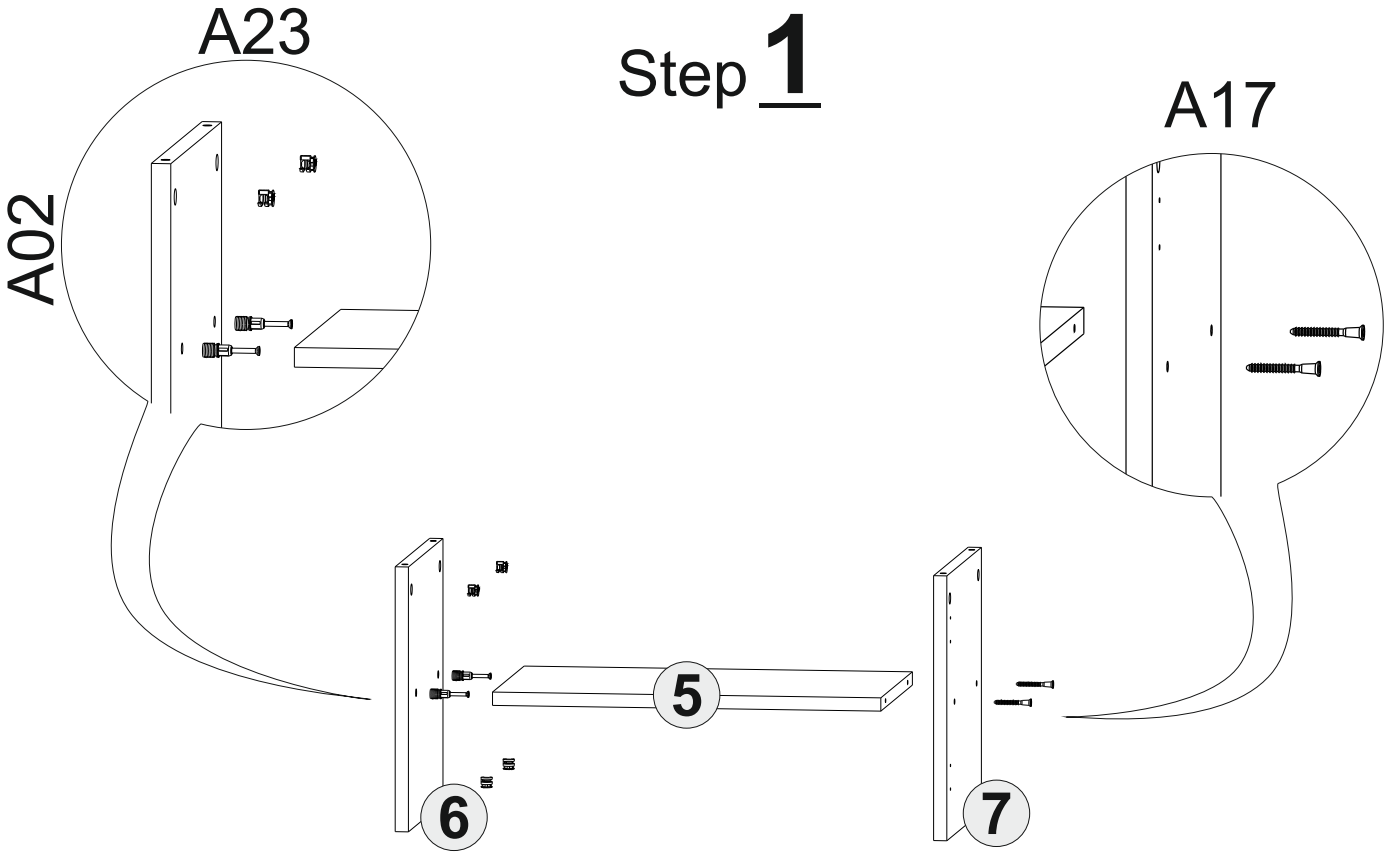

Step 2

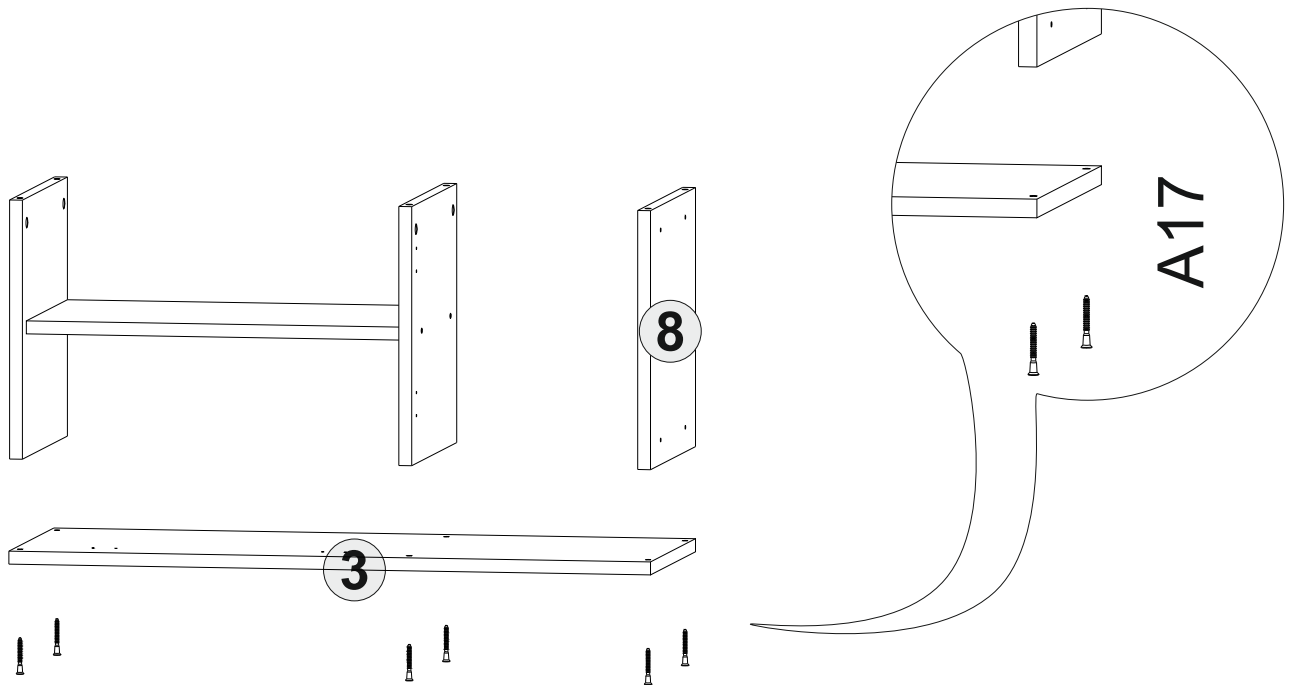

Step 3

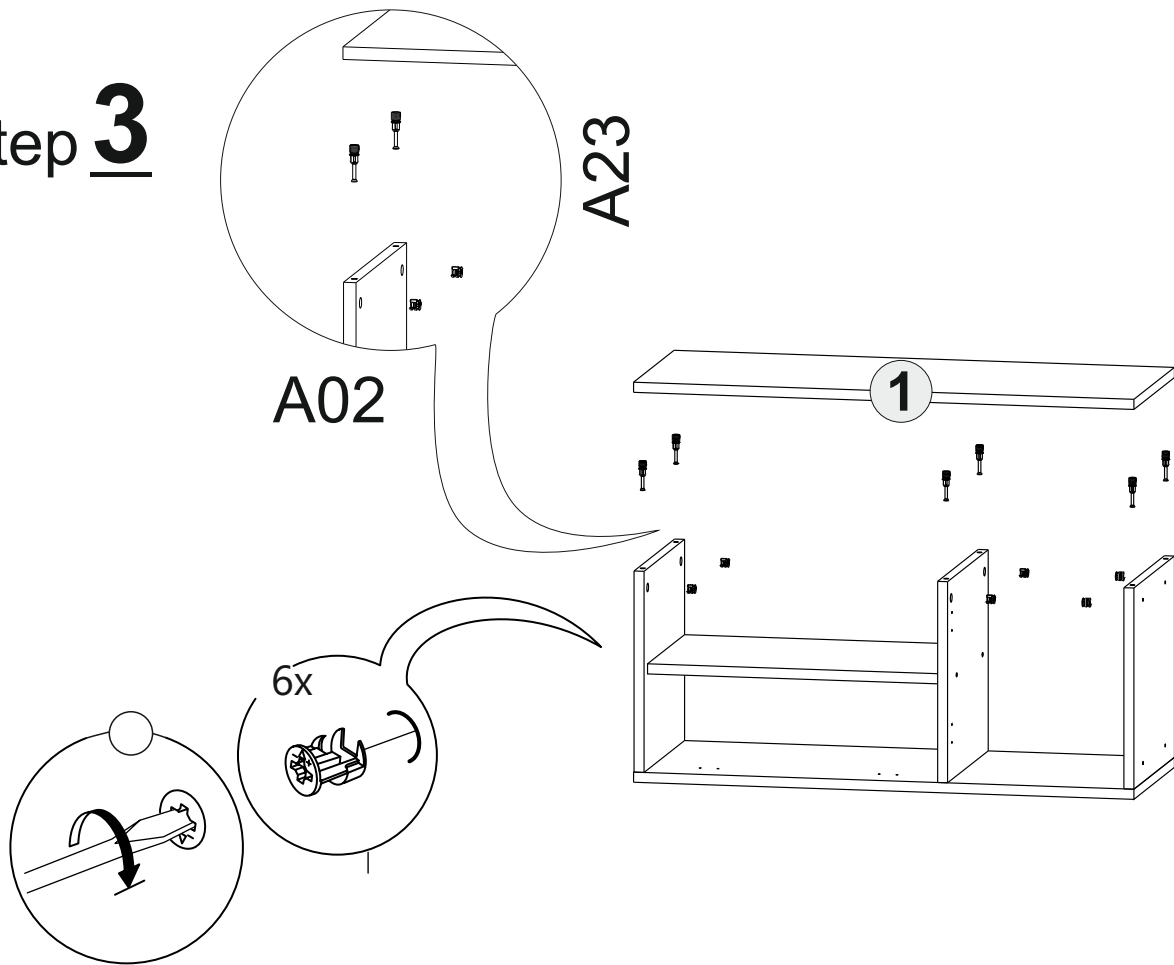

Step 4

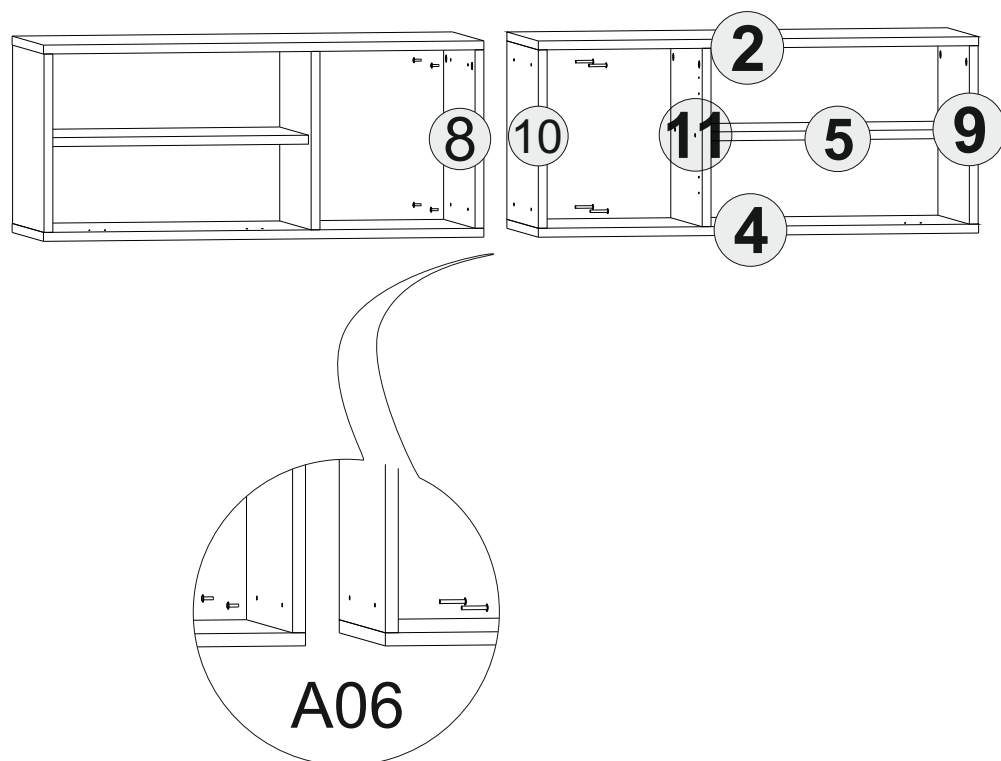

Step 5

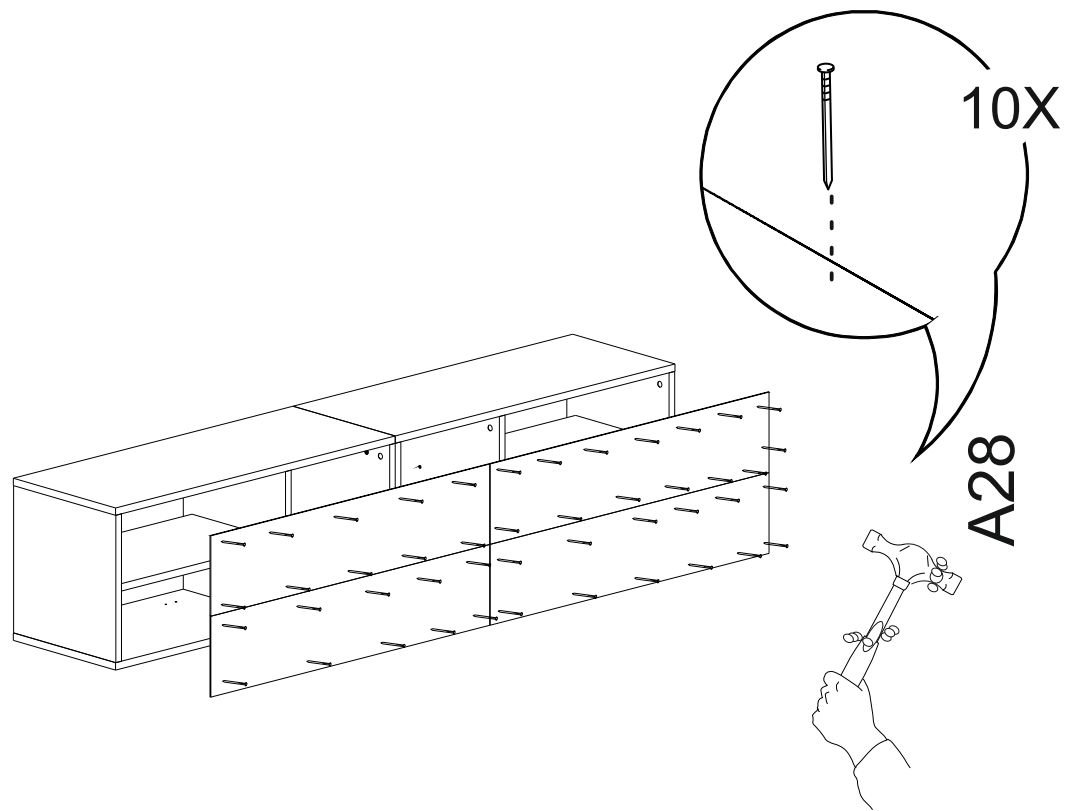

Step 6

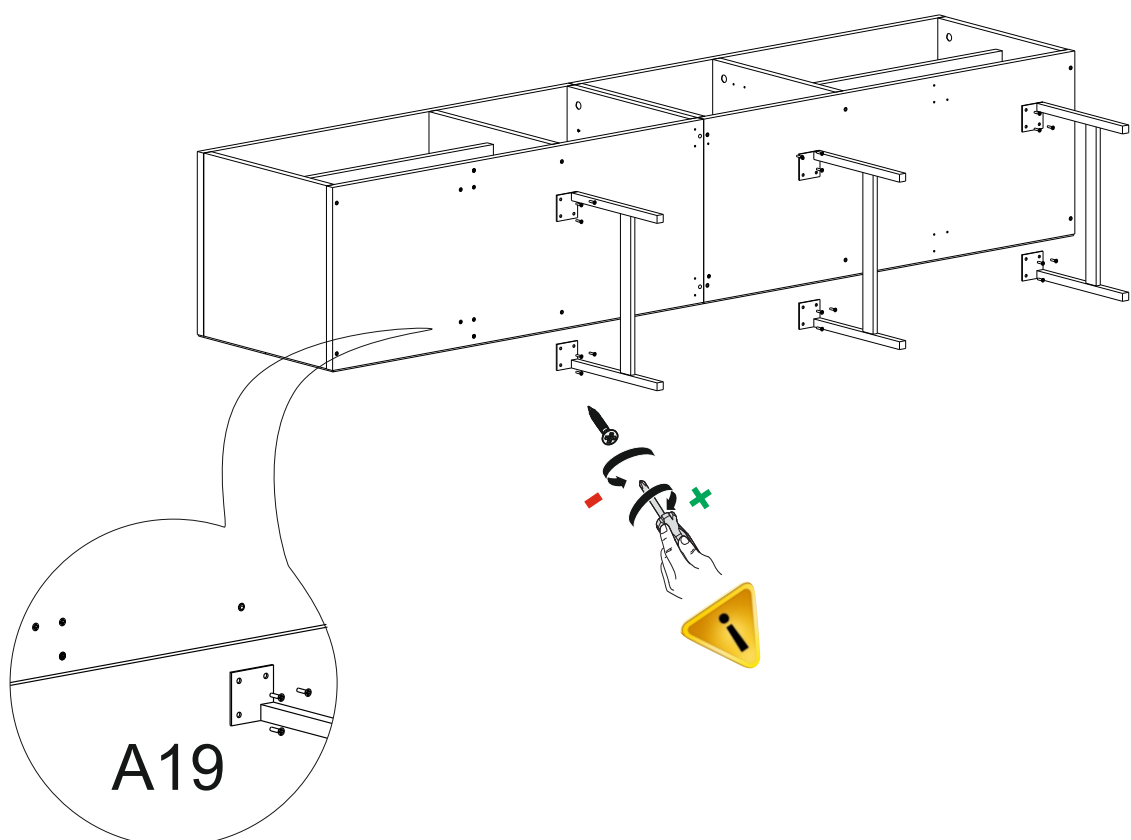

C02 for parts #14 , C01 for parts #12 , #13

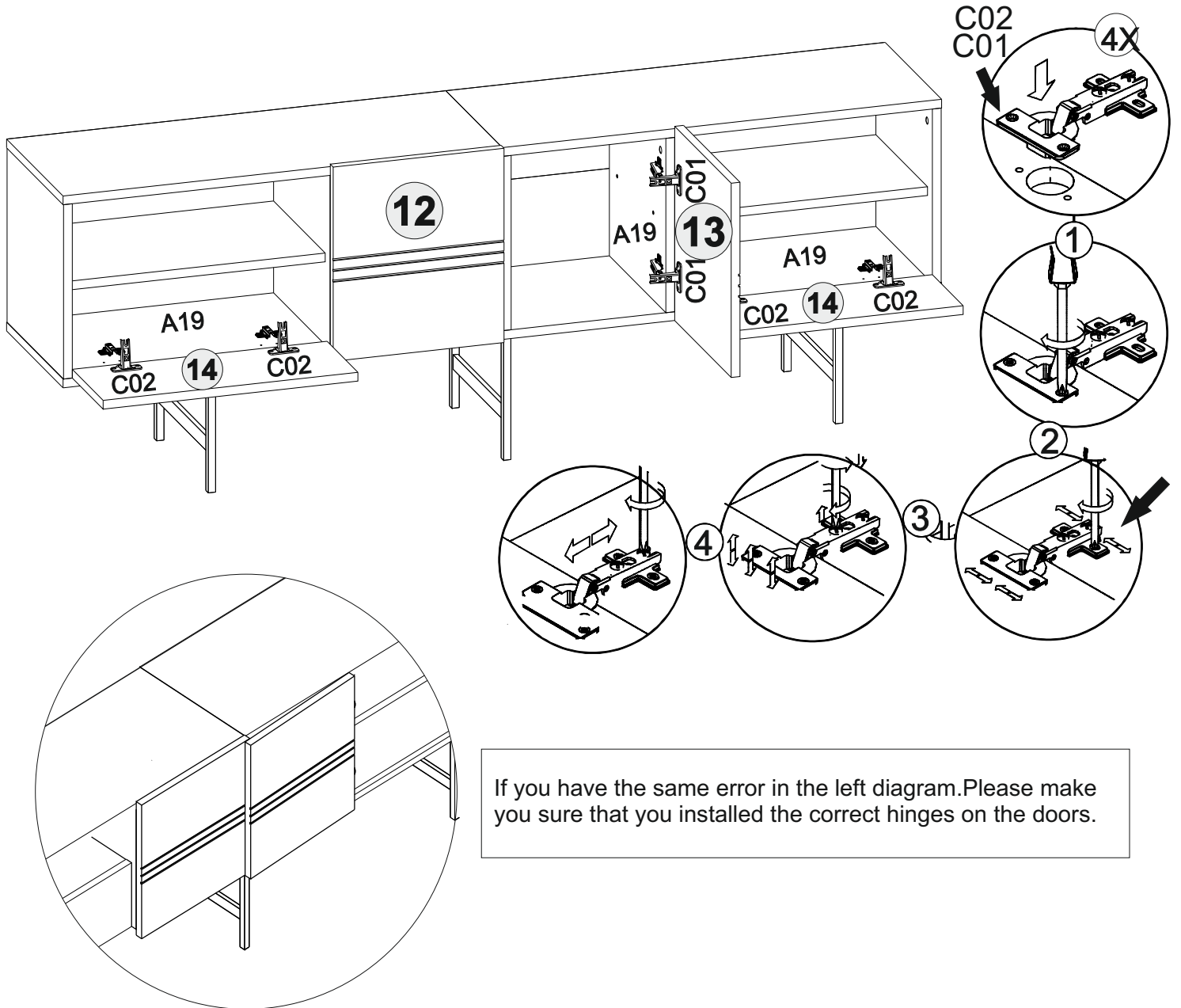

If you have the same error in the left diagram. Please make you sure that you installed the correct hinges on the doors.