

120-000359

# Tv Stand

## Assembly Instruction

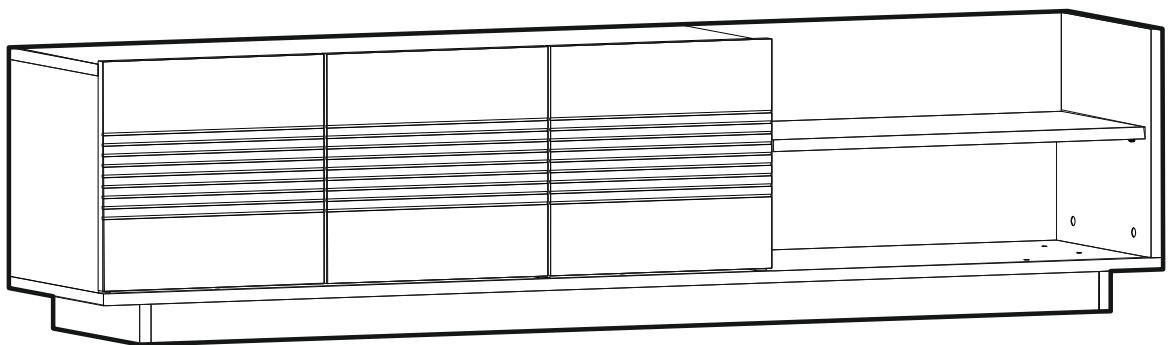



Valued Customer,

We design and carefully manufacture our products for our customers, We wish that our customers to have fun while they are doing their new furniture

The product you just purchased was subjected to all sorts of tests and controls before sending out to you.

Hope you enjoy your new furniture.



Before starting, please check all components and accessories according to the provided list. If you purchased more than one product, to prevent confusion, be sure that you completed the first product, then start the next one. Please make sure that you select correct numbered part and use specific connector to assemble. We do not recommend any modification or rotation in assembly. Please follow the manual carefully.



Furniture parts are going to several manufacturing procedures. During this process, parts can have little dust or marks. Please clean the parts with damp cloth before assembly to get the best result. Usual cleaning would be suffice.



Although all products are carefully manufactured and packed, sometimes we experience damage during transportation. In such cases, please check the damaged part, note the part number written on the part and do not hesitate to contact us



Do not use your furniture for out of purposes. If you would like to use it out of purpose or would like to do some modification or rotation, please contact us for more details.

Please do not expose your furniture with excessive heat, cold and humidity because product can be affected negatively.

If you need your product to mount on the wall, Please use suitable rawlplug for your wall type. We send you rawlplugs suitable for concrete and brick walls.

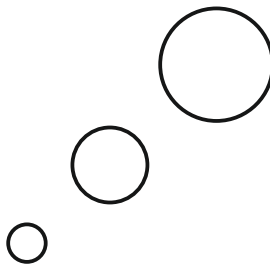
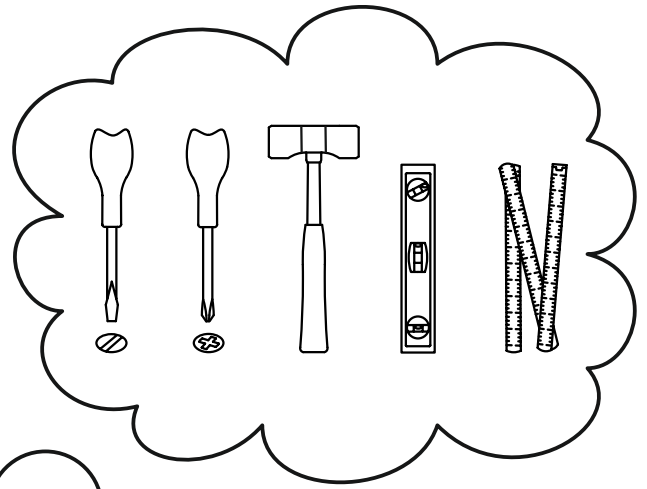
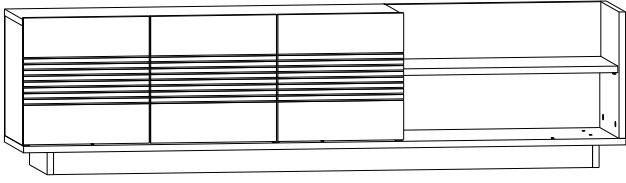

## Disassembled Parts

Part#1	1x
Part#2	1x
Part#3	1x
Part#4	1x
Part#5	1x
Part#6	1x
Part#7	1x
Part#8	1x
Part#9	1x
Part#10	2x
Part#11	3x

---

**TOTAL 14**

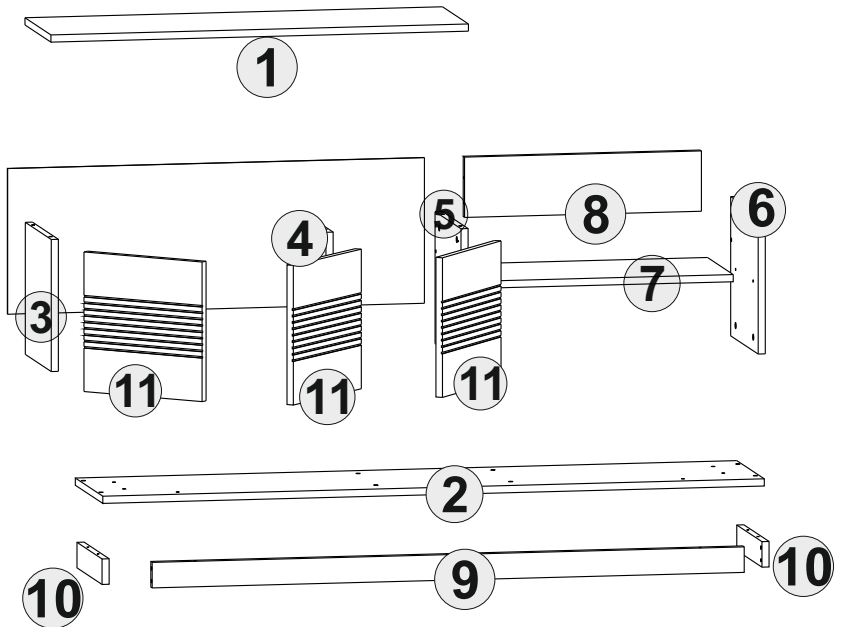

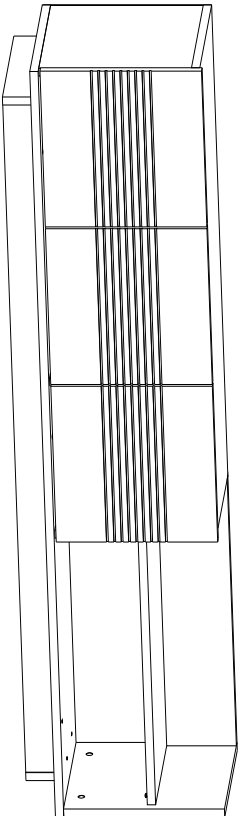

# Tools & Installation Components

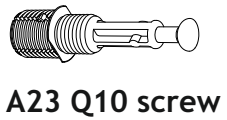

14X

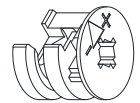

14X



11X

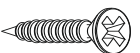

24X

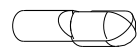

4X



14X



9X



4X

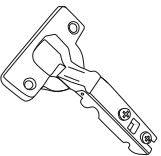

4X

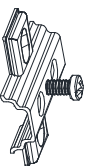

6X

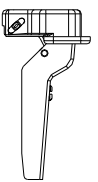

2X



20X



Please be aware that C01 (bracket) and C04 (pivot) parts may come as attached together.

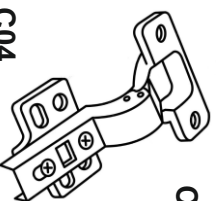

C04

C01

# Step 1

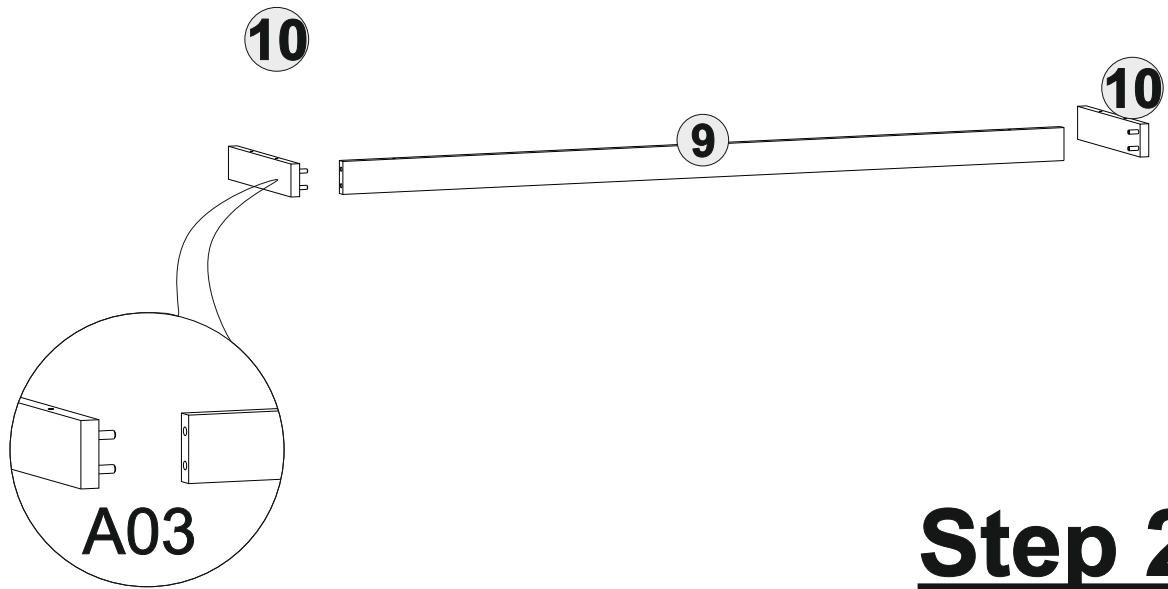
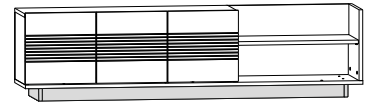

# Step 2

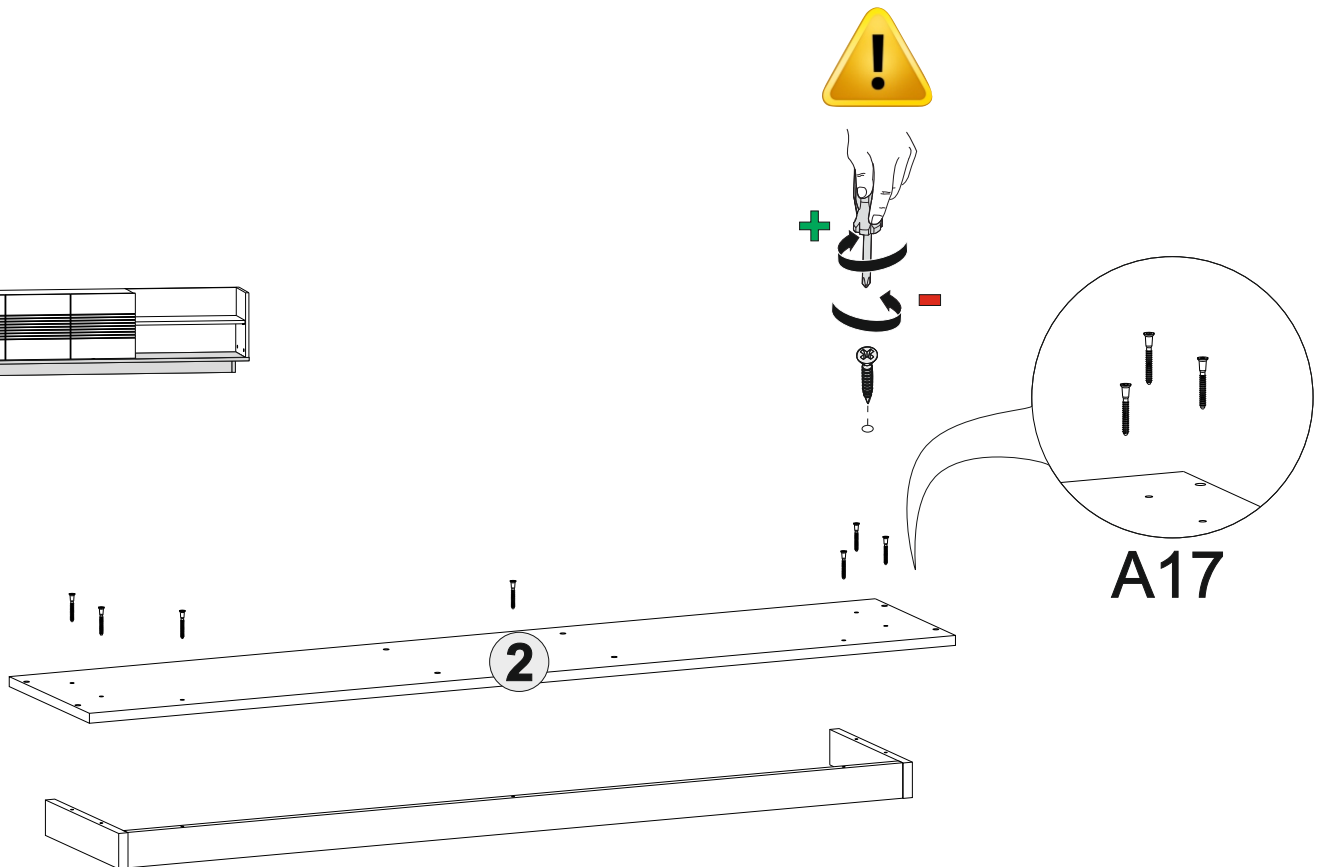
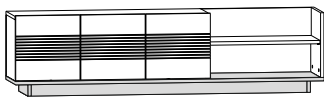

# Step 3

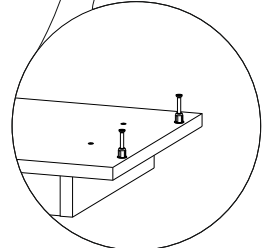
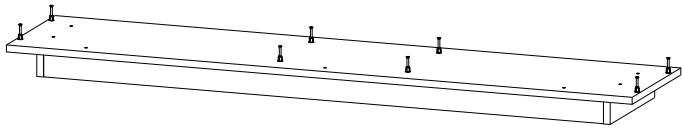
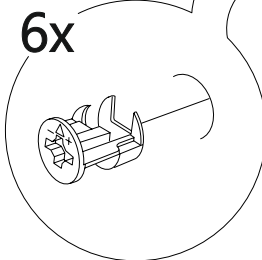
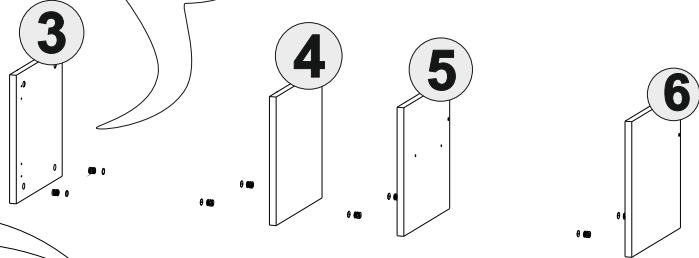
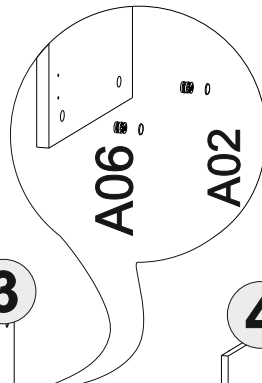
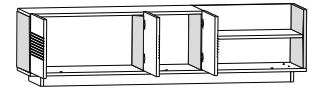

# Step 4

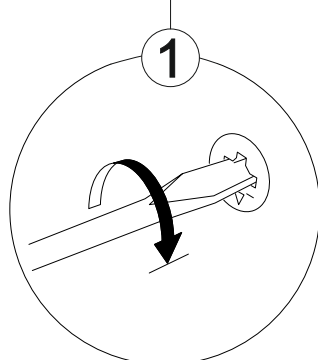
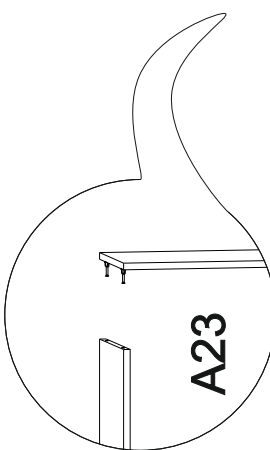
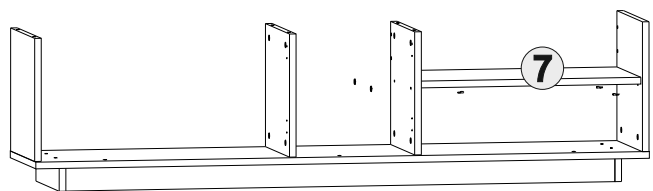
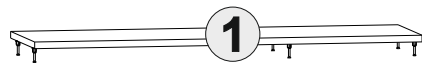
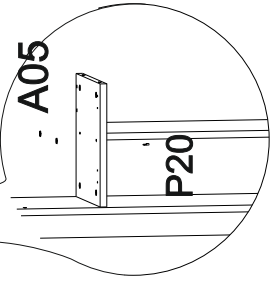
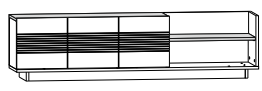

# Step 5

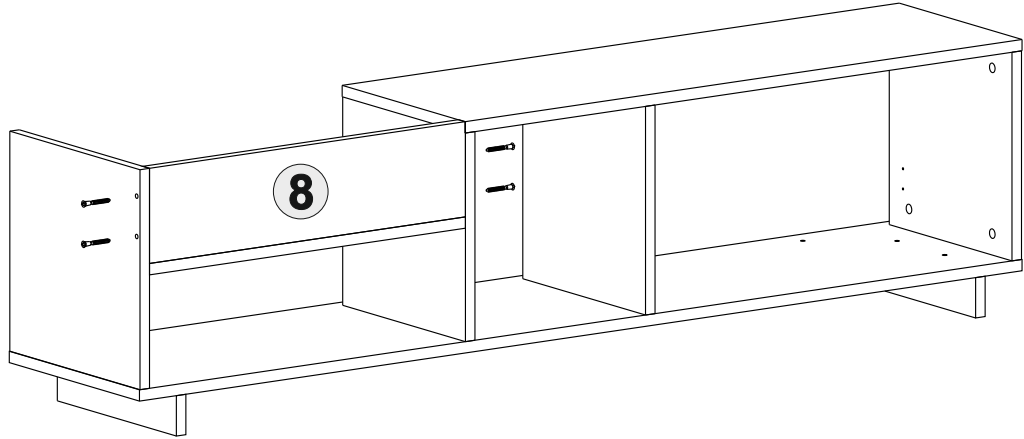
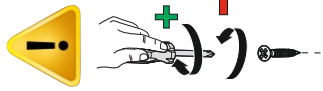
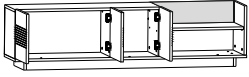

# Step 6

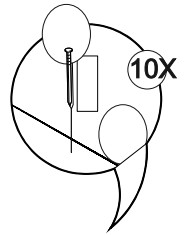
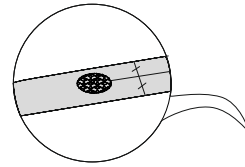
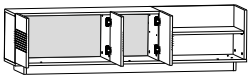

A28

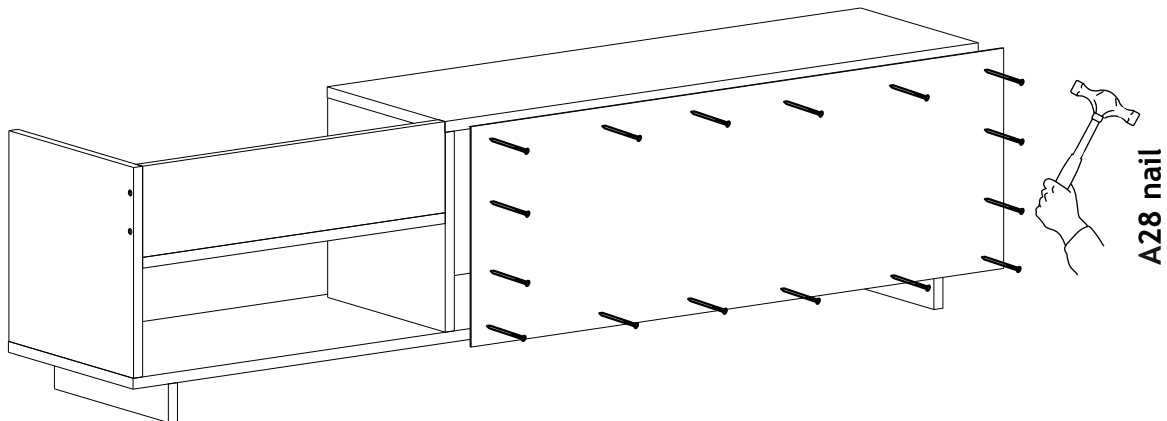

Please do not neglect installing the back panel of the TV stand. Installing the back panel will both make your TV stand sturdier and look better.

# Step 7

There are two types of hinges on this TV unit. Please do not confuse the hinges C01 and C03.

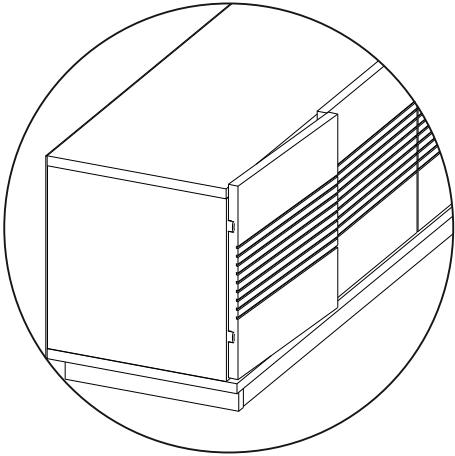
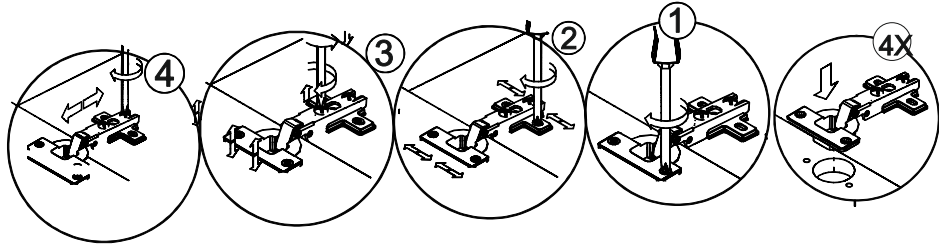
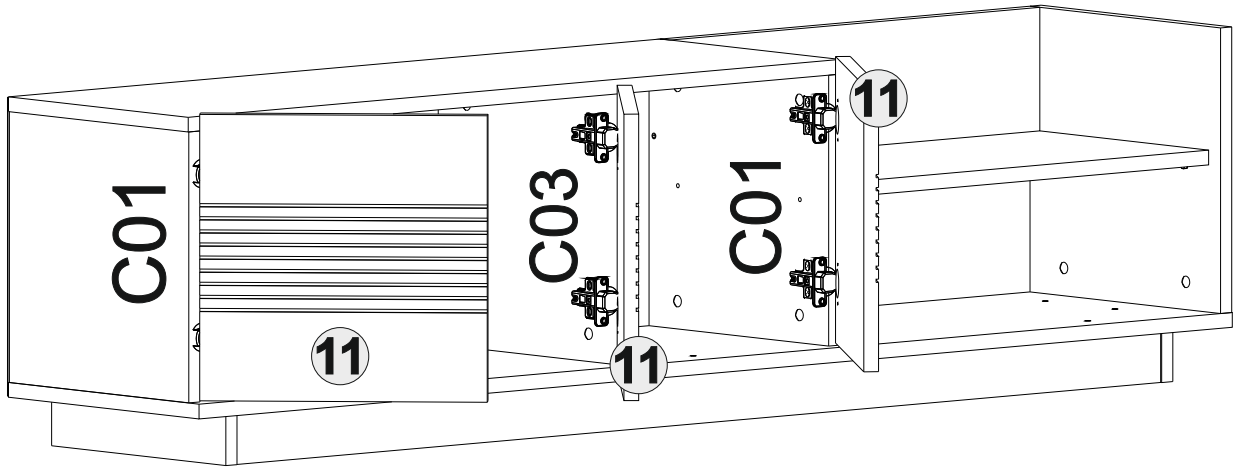
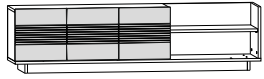

If you have the same error in the left diagram. Please make you sure that you installed the correct hinges on the doors.