



# KR08-2

ITEM	(A)	(B)	(C)
ACCESRIOS			
	4CM	3CM	2CM



## STEP A:

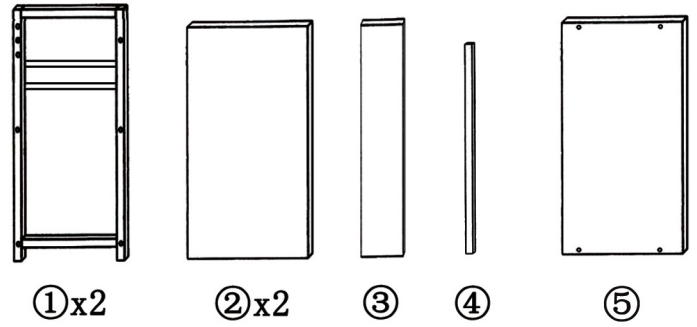
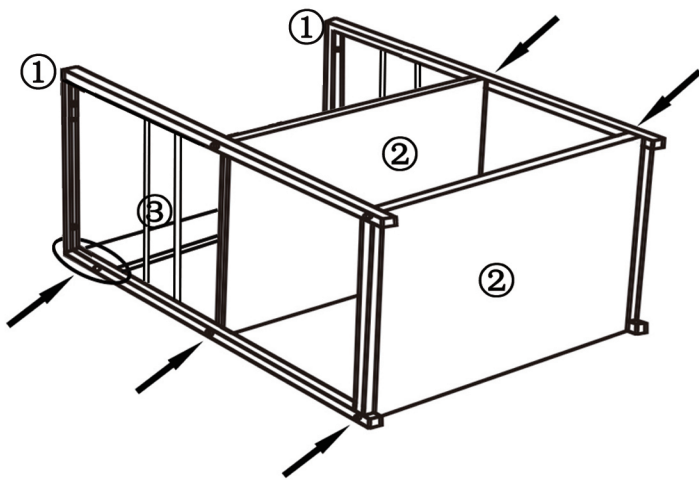

Fix it with (A)

## STEP B:

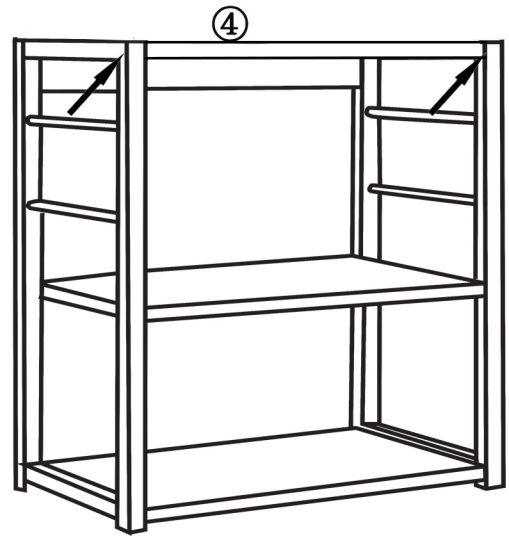

Fix it with (B)

## STEP C:

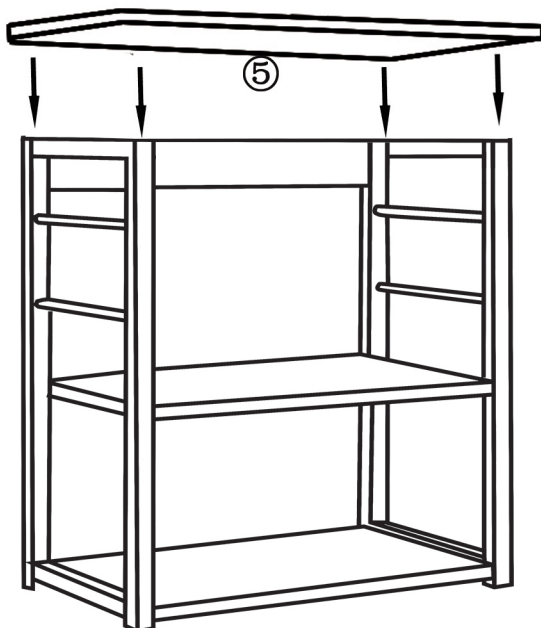

Fix it with (C)

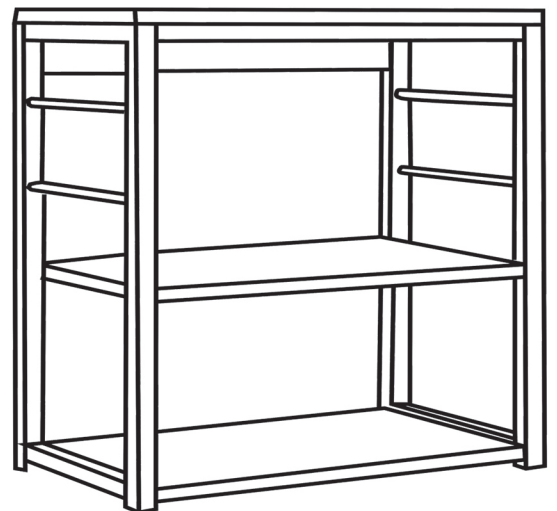

DONE!