

# STL-DK02 Assembly Drawing

Pakketo code:069-000033

Size:W1500\*D750\*H750

Tools

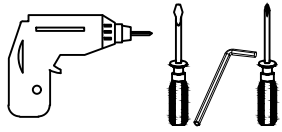

## Connecting Parts

A		10	G		
B		10	H		
C		6	J		
D			K		
E			L		
F			M		

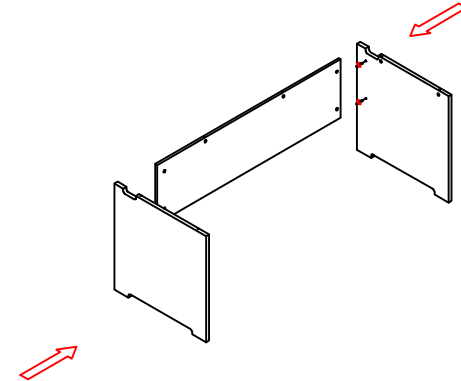
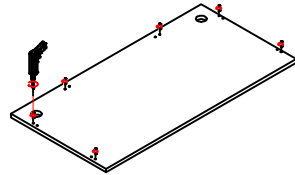

1  
3

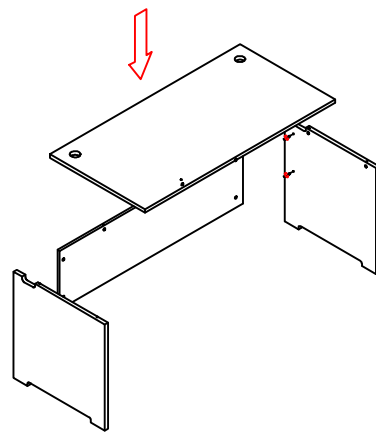
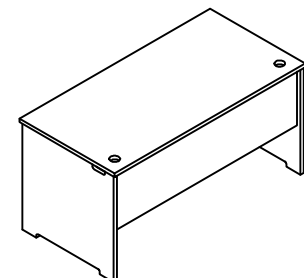
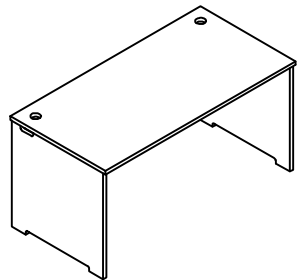

2  
4

Finish